

# tomorrow

EXPERIENCING TECHNOLOGY WITH SCHAEFFLER

## Innovations for the future

Lightweight design, micromobility  
and other pioneering ideas

## Innovations throughout time

A brief survey of mankind's  
most important inventions

**»» *Completely new correlations are not discovered by the eye that is hunched over a workpiece but the eye that scans the horizon with ease***

Prof. Dr. Carl Friedrich Freiherr von Weizsäcker



## DEAR READER,

No other article in the fourth issue of our technology magazine ‘tomorrow’ was as hotly debated as the one about mankind’s most important inventions: the wheel, the bow and arrow, the steam engine, electricity, the computer or the internet? The discussion was continually fueled by new suggestions and we ultimately filtered out the 30 most important ones for you – without any claim to their universal validity.

While it’s difficult to create a ‘best of’ list of the most significant inventions, it’s actually impossible to determine the one that’s the most important of all, as every invention is based on another one. Without tools that were created more than two million years ago, our ancestors could not have chiseled the first wheel out of stone. Without wheels there’d be no vehicles, no automobiles. In antiquity, scholars were the first to experiment with electricity, without which a modern world with computers and the internet wouldn’t be possible.

Innovations not only require creative ideas and inspiration but, above all, courage and vision. For Schaeffler, innovation has been an integral component of the company’s DNA. Thinking out of the box is very important to us – this particularly applies to our interdisciplinary Innovation Management team that we’re presenting to you in this issue of ‘tomorrow.’

Innovation is rarely the result of bright ideas or sudden inspiration. Innovation can be achieved through work. It’s the result of systematically analyzing new trends and needs, elaborating new ideas, and a deliberate effort of turning them into reality and ultimate market success. More than anything else, this requires strong technological expertise and knowledge of potential applications and markets. All this played a part in a Schaeffler innovation in the field of micro mobility as well. Start reading on page 102 to find out what this is about.

To find new solutions for the future, at Schaeffler, we not only rely on the creativity of our own engineers

but also on our collaboration with universities and external partners around the globe. In addition, we’re engaged in a dialog with other technology companies, from start-ups to global players, on a regular basis.

The courage and will to be innovative is not only important for us and other technology companies. Economic history is full of innovation-driven success stories but also of examples of companies that blinded themselves to progress or recognized trends in technology and society too late. This, too, is a topic in this magazine.

China has evolved from a low-cost country into an innovation driver in recent years. The fact that the Middle Kingdom is currently home to three of the world’s top ten companies in terms of sales is just one indication of the country’s economic importance. The current issue of ‘tomorrow’ provides you with an insider’s view of China’s rise.

No matter from what angle you look at it, innovation is an equally multi-faceted and exciting topic. I wish you an enjoyable read and interesting insights into the world of innovation.

A handwritten signature in black ink that reads 'Klaus Rosenfeld'. The signature is fluid and cursive, with a large, stylized 'K' and 'R'.

**Klaus Rosenfeld**  
Chief Executive Officer

## global

Innovation without borders

### 8 HUGE COUNTRY WITH HUGE POTENTIAL

**China** has evolved from a low-cost country into an innovation engine at a record pace

### 16 HEAVY DUTY

In deep mining, on the beach, as a mobile garage in Africa – **trucks** can handle a wide variety of tasks. Insights and innovations from five continents

### 26 TRAFFIC CONGESTION

Too many cars, too many obstructions, and too little space: **traffic jams** are a nuisance. Modern technologies are designed to improve traffic flow

### 32 FIELD OF RECORDS

Bigger, faster, and increasingly efficient and advanced – **agriculture** has become a high-tech playing field in the last decades



## in motion

Innovations in the course of time

### 40 CONTROL CENTER

Be they manual, automatic or continually variable – Schaeffler has been developing clever solutions for all types of **transmissions** for decades

### 46 FROM THE STONE TOOL TO THE INTERNET

An inspiring time journey through the most important **inventions** in the past 2.6 million years

### 54 THE CAR ACCELERATORS

Even though it doesn't say so on any car, a wealth of Schaeffler **know-how** is underneath the body shell – and has been for 70 years

### 62 INNOVATION CULTURE

Only **companies** that don't blind themselves to new ideas have a chance of survival in a world that's turning faster and faster

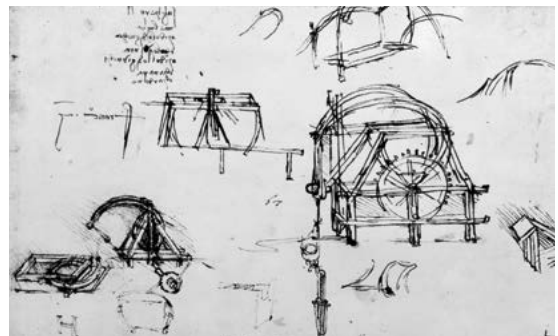



## here and now

Living with progress

### 68 ONE IDEA AFTER THE OTHER

Progress is a transmission with many gear wheels. One **idea** drives many others forward

### 72 THINKING OUTSIDE THE BOX

Schaeffler's **innovation management** uses 'aliens' and the Disney method to work on forward-thinking projects

### 78 LIBRARY OF INVENTIONS

A tour of the world's smartest office: the **German Patent and Trademark Office** in Munich

### 82 TO VICTORY WITH VOLTS

Team ABT Schaeffler Audi Sport is competing in **Formula E** with a proprietary development of a powertrain for the first time. A glance under the hood



## outlook

Technology for tomorrow

### 90 ON A DIET

**Lightweight** design is the trend, especially when it comes to means of transportation. Every kilo that's not being moved saves energy

### 96 HOMO SAPIENS 2.0

**Exoskeletons** instead of magic potions: innovative technologies provide the human body with additional capabilities

### 102 NEW CITY SPEEDSTERS

Are cities threatened by total gridlock? Some approaches give rise to hope – such as **micromobility** that Schaeffler has been driving forward

### 110 BYTES INSTEAD OF BITS

Repairs on demand, diagnosis by WLAN – **automotive garages** on the way to the future

### 114 MASTHEAD





»» *If at first the idea is not absurd, then there is no hope for it* Albert Einstein





# global

Innovation without borders

## AS IF **BY MAGIC**

— Cold, loud, musty, concrete chic as far as the eye can see. These were the parking garages of yesterday. Visitors to the new main library, the citizens' services and Dokk1 cultural center in the Danish city of Aarhus can consider themselves lucky. In December 2015, a very special innovation opened its gates – the largest fully-automatic parking garage in Europe. And here's how the all-round feel-good experience works: drive into one of the 20 ground-level elevators, turn off the engine, take a ticket, and you're done. The rest is taken care of by the super parking assistant developed by the German company Lödige Industries. The car is transported underground by an elevator, picked up there by an automated transfer vehicle and chauffeured to a free parking space. The so-called shifter, a flat robot, slides under the car, lifts it and places it into the parking spot. The total parking time, from arriving to taking a ticket, as well as the retrieval time, from paying to getting the vehicle back, should take only 60 to 120 seconds. Ingenious: the 'shopping drop-off' service where a customer summons the car, stows shopping bags and sends it back to its spot. —



# “THE BEST CONSUMPTION STORY IN THE WORLD”

From an underestimated country of laborers to the middle kingdom of technology and business – China’s rapid development within the past quarter of a decade.

— by *Christiane Kühl*







The district of Pudong in Shanghai in 1989: a monotonous sight and sparsely populated. Then came the Chinese boom. Thanks to annual economic growth of up to 20 percent, Pudong has since seen dramatic changes (large picture)

— 25 years ago, millions of people would still be riding their bicycles through large gates, passing signage that said: Gao Gao Xing Xing Shang Ban, Ping Ping An An Hui Jia – Get to work cheerfully and back home safely! It was the slogan of the Chinese state-owned enterprises which, in spite of some subtle steps toward liberalization, still dominated the economy back in those days. The first privately owned small companies already existed, as well as roadside shops and vegetable markets. Ten years

later, a prospering region for light industry had emerged in southern China where migrant workers from the hinterland were producing cheap plastic tubs, clothing, electronic components or microwave ovens for the whole globe, earning low wages as the ‘workbench of the world.’ Along the railroad between Hong Kong and Guangzhou, the capital of the booming Guangdong province bordering the former British crown colony, peasants were still cultivating their rice paddies by hand as late as in 1991. In 2001, only the hills would be seen in their natural green splendor, while in the lowlands factory halls, dormitories for migrant workers, and cities with millions of people were lined up side by side. From rice paddies, channels, and fishing villages along the Huangpu River across from Shanghai’s waterfront boulevard, the Bund, the Lujiazui financial district began to emerge in 1992, boasting three of the world’s tallest skyscrapers. In 1991, most trains were chugging along through the country at 50 kilometers per hour. Today, about 60 percent of the world’s high-speed rail tracks, covering a distance of 19,000 kilometers, traverse China.

---

### ***China is the world’s major economic growth engine***

---

Between 1985 and 2015, China’s economy recorded 9.4 percent average annual growth, according to McKinsey Global Institute (MGI). It was fueled by reforms which liberated large parts of the economy from



The container port of Shenzhen is one of the largest of its kind



the shackles of government planning, as well as a sheer endless flow of young migrant workers from the hinterland. The government itself concurrently drove the development of infrastructure, large-scale industry, and real estate. “Today, China contributes 37 percent to global economic growth. No other country even comes close to resembling this influence,” says Jack Perkowski, founder of the investment firm JPF Holdings in Beijing.

By now, China is importing large quantities of raw materials, upstream products, and machines. That’s why the world fears a drop in growth. China’s economic growth in 2015 amounted to only 6.9 percent, a rate as low as it had last been 25 years ago. President Xi Jinping is endeavoring to bring the population to terms with permanently lower growth, referring to this state as the ‘new normal.’ Many sectors are suffering from excess capacity, the debt of the local communities and the banks has increased to dangerous levels due to a number of stimulus programs, and privately held companies are still having difficulties getting loans in a system that’s dominated by state-controlled banks. Ever since the beginning of the reform era, there has been a continually widening gap between the rich and poor. In December 2015, industrial production was only 5.9 percent above the same month in the prior year. The old heavy industries, such as cement or steel, which are dominated by state-owned enterprises, are showing signs of weakness. China is currently made up of multiple sub-economies, says Gordon Orr, Director Emeritus and China expert at McKinsey, in his annual forecast for 2016 – each of them more than a trillion dollars in size: “Some are booming, some declining. How you feel about China depends more than ever on the parts of the economy where you compete. In 2015,

selling kit to movie theaters has been great business, selling kit to steel mills less so.”

---

### *Quality is the new quantity*

---

China is at a turning point, moving away from the old growth model of gaining world market share as fast as possible with cheap products, copying, and becoming industrialized, toward an innovative, consumer-oriented economy. The government intends to have obsolete capacities of the iron, steel and coal industries displaced from the market – not least in the interest of protecting the ailing environment. Today, retail sales are growing faster than the economy as a whole. Purchasing power is increasing as China’s rural population has long become urbanized: In 2015, over 771 million Chinese, accounting for 56 percent of the total population, permanently live in cities. The percentage of those who are able to spend more than 20 U.S. dollars per day has grown from three in 1990 to 25 percent today, according to information of the International Monetary Fund. The legal minimum wage has been significantly increasing for years – in Shanghai by 187 percent in the past decade.

The economic miracle began in 1979 when patriarch Deng Xiaoping established the first Special Economic Zone (SEC) in Shenzhen where initial experiments with



---

**» In the future, China will have to increasingly be regarded as an automotive trendsetter**

Zhang Yilin,  
CEO Schaeffler Greater China

---



market mechanisms, foreign trade, and direct foreign investment took place. Privately held companies were progressively allowed. Subsequently, SEC policies were extended to the whole country. Deng permitted some regions on the coast to 'get rich first.' Shenzhen itself was a fishing village in 1979 and in 1991 had an office tower with a glass front. Today, Shenzhen is a metropolis with a population of far more than ten million who migrated from all of China. The current minimum wage of 2,030 yuan (284 euros) per month is the highest in the whole country. The city is home to China's most innovative companies, such as the privately held telecom equipment supplier Huawei that spends twelve percent of its earnings on research. The former battery manufacturer BYD produces electric cars based on its own proprietary developments the standards of which continually improve. Shenzhen DJI is the global market leader for civilian drones. Founder Frank Wang, now aged 34, invented systems and algorithms to transmit the drive to the rotors that stabilize the unmanned aerial vehicle and the camera while he was still at university.

"China is strong where the starting bases are the same for everyone – for instance, with internet services and electric mobility," says Christian Sommer, CEO of the German Center in Shanghai that rents facilities to German medium-sized companies. China's companies are also good at developing new consumer products and

in process innovation for efficient manufacturing, MGI says in a current study: "China benefits from the sheer size of its consumer market, which helps companies to commercialize new ideas quickly and on a large scale." By outsourcing entire production steps, for instance, companies create efficiency. In Shenzhen, a network of thousands of component suppliers, design services, and business incubators is enabling rapid prototyping and scaling up of mass production, according to MGI: "Design firms in Shenzhen can turn ideas into prototypes in as little as one-fifth of the time and at half of the cost for doing such work in-house." In terms of scientific innovation – such as the development of new drugs – or in engineering-based innovation, China is still lagging behind. Products made by traditional industries aren't able to keep up with those of the competition in industrialized countries yet.

---

### *Change of thinking in the automotive sector*

---

China's state-controlled automobile manufacturers, for instance, were highly profitable for many years due to their joint ventures with foreign automakers but neglected their own developments. Today, the government is supporting innovation in this sector. It subsidizes electric vehicles, promotes smart city projects, and requires automakers to utilize fuel-saving technologies.



A luxurious Rolls-Royce versus a fully loaded bicycle: the gap between the rich and poor in China is large





Modern times meet tradition: in spite of a wealth of technological innovation such as the CRH 380A high-speed train (left) the traditional world still exists in China as well





“Automobile manufacturers in China will have to reduce their fleet consumption to five liters by 2020. That will be hard to accomplish without electrification,” says Zhang Yilin, CEO of Schaeffler Greater China. Specifically for China, the Schaeffler E-Mobility Division has developed complete platform solutions which then only have to be adapted to customers’ needs. The technological prerequisites of the customers in China enormously vary, according to Zhang. “There are many customers we can’t just supply with components but to whom we have to deliver a full system which is then integrated into the car. That’s why we’re offering complete systems in the field of electric mobility. Together with one customer we even built a concept car to demonstrate in concrete terms how our system works.” In addition, Schaeffler’s engineers in the Shanghai suburb of Anting developed a number of concepts such as a hybrid module adapted to China’s standards, an E-Axle, and so-called In-Wheel Drive Units, an electric wheel hub drive system in which the electric motor, the brakes, and the cooling system are installed underneath the rim of the wheel. In China, countless electric scooters using In-Wheel-Drive Units are on the road.

“The demand for cars with alternative power-trains and connectivity is drawing more and more new

players into the automotive industry,” says Jack Perkowski. For instance, China’s leading search engine, Baidu, is working on a self-driving car. Tencent, known from the WeChat social media platform, teamed up with the Taiwanese electronics giant Foxconn and jointly launched an intelligent e-car. The online television company LeTV is developing connected cars and invested in a company that produces charging stations for electric vehicles. The sector is still small but currently booming like never before. The Association of Chinese Automobile Manufacturers that is closely linked to the government anticipates sales of electric vehicles and plug-in hybrids to double to some 700,000 units in 2016 after previously having recorded an increase by 340 percent to 331,000 in 2015. The government pays subsidies for the purchase of these cars and recently announced plans to accelerate the development of the charging infrastructure. Overall growth of passenger car sales in 2015 by 7.3 percent to 21.1 million cars was relatively weak, though. Due to congestion and air pollution, big cities are imposing limits on new vehicle registrations, their markets are saturated. “Sales in small towns and rural areas, however, continue to grow in the double digit range,” writes Yang Jian, one of the country’s leading auto journalists. “One shouldn’t forget that the



## GROUNDWORK

**Among the organizations contributing to innovation in China are the country’s leading universities. One of them is Tongji University in Shanghai which has a tradition of fostering close relations with Germany. There, at the Chinese-German College for Postgraduate Studies (CDHK), Schaeffler established an endowed chair for automotive engineering in 2007. Schaeffler’s Chief Technology Officer Prof. Peter Gutzmer is one of two dozen guest lecturers there. Professional colleagues from Schaeffler China regularly teach there in their particular fields as well. Seminars are held in German, English, and Chinese. Access to the talent pool of well-educated and highly motivated students is an important reason for the CDHK commitment, according to Gutzmer. A high level of public awareness makes a company more attractive for graduates. Therefore, Schaeffler cultivates contacts with universities at practically all of its locations.**

density of automobiles is still very low in China. There are still only 124 cars per 1,000 inhabitants.”

---

## **China is not free from troubles**

---

For 2016 and the following years, analysts are anticipating growth of about six percent. Layoffs due to a growing number of businesses going bankrupt, declining exports to the west that’s been showing signs of weakness, plus lower competitiveness in labor-intensive sectors due to higher wages are the risks seen by analysts. Furthermore, due to the one-child policy that was just recently loosened, China’s population is aging even before the country has reached the level of prosperity. The total number of the working-age population might peak as early as in 2016, according to an MGI estimate. The gap between the rich urban and poor rural population is only closing slowly.

But, generally speaking, the upward trend continues. In the cities, disposable income in 2015 increased by 6.6 percent to 31,195 yuan (4,385 euros), in rural regions just slightly faster by 7.5 percent to 11,442 yuan. As a result, the disposable income of the rural population has nearly doubled compared with 2010 (5,919 yuan) and increased by about 50 percent (19,109 yuan) in the cities. Today, the major portion of the goods produced in China is no longer intended for sale to foreign countries anyhow – exports ceased to be growth drivers years ago. In contrast, retail sales in 2015, at 31.1 trillion yuan, were almost twice as high as in 2010. Consumption contributed 66.4 percent to economic growth – compared with just 46.3 in 2010. Furthermore, in 2015, services accounted for about 50 percent of the gross domestic product for the first time – which is always a sign of a more mature economy. Plus: “While GDP rose by ‘only’ 6.9 percent last year, that came on a base that was about 300 percent bigger than it was a decade ago,” says Andy Rothman, an economist with the investment firm Matthews Asia, “meaning that the incremental expansion in China’s economy last year was about 60 percent bigger than it was back in the day.” Rothman is one of the optimists in his field: “In my view, China has become the world’s best consumption story.”



### **THE AUTHOR**

**Christiane Kühl** has been living in China with her family since the beginning of 2000 – mostly in Beijing, with three years in between spent in the coastal metropolis Shanghai. Her work is focused on business and environmental topics, plus exploring this huge country full of contrasts that she traveled with a backpack for the first time in 1992.



### **DIGITAL NATIVES**

*In China’s cities, young people sitting at a restaurant table hunched over their smartphones are not an uncommon sight. They use mobile devices to chat, shop or look for stores. They compare offers on the used car market or check stock quotes. Social media play a much greater part in everyday life than they do in Europe. In addition, web-based services are an important source of customer-oriented innovation.*

*The Alibaba Group’s business began to flourish with online shopping portals, which are being used far more frequently in China than in the western world. In addition, the company launched the Alipay payment system that now also operates for other online services. As a smartphone app, Tencent’s WeChat combines the functions of Facebook and WhatsApp, and offers online shopping opportunities, payable via WeChat Wallet, as well. Tencent not only relies on advertising, but primarily makes money by offering these services and by selling virtual gimmicks to online gamers.*

*“Mobile payment skips debit and credit cards,” write Jan Borgonjon, David Sinclair, and Simon Zhang from InterChina, a Shanghai-based consultancy. Recently, Alipay and WeChat Wallet were even linked to platforms for the stock market so that users can quickly check quotes first thing in the morning. Therefore, social media are a must for foreign companies seeking to tap China’s consumer goods market. “Preferences in China change at breathtaking speed – so that for new trendy products there’s an immediate large-volume demand due to the country’s size,” says Thomas Heck, partner and head of the China Business Group of PwC Germany based in Shanghai. In order to be able to quickly respond to such trends, companies have to know their way around social media and monitor them: “Marketing and sales in China use social media, which are also important channels for new trends, a lot more intensively.”*



## FACTS ABOUT CHINA

— Official Chinese name of the country: *Zhonghua Renmin Gong-heguo*

— Area: *9,572,900 square kilometers*

— Population: *1.37 billion Inhabitants (2014)*

— Religions: *most Chinese are unaffiliated with any religion. Traditional religions and religious-philosophical traditions: Buddhism, Taoism, and Confucianism*

— Agricultural products: *burlap, corn, cotton, potatoes, rice, soy beans, sugar cane, sweet potatoes, tobacco, wheat*

— Natural resources: *antimony, bauxite, coal, diamonds, crude oil, gold, graphite, iron ore, lead, mercury, manganese, molybdenum, natural gas, phosphate rock, tin, tungsten, zinc*

— Share in gross domestic product: *agriculture 9%, industry 43%, services 48%*

— Unemployment rate: *3.4% (2013)*

— Life expectancy: *men 74 years, women 77 years*

— Compulsory education: *9 years*

— Access to clean drinking water: *98% of the urban and 85% of the rural population*

— Tourism: *55.7 mill visitors (plus Hong Kong: 25.7 mill visitors)*

The Chinese Wall stretching across thousands of kilometers is the country's major landmark



# GLOBAL

Be it in deep mining or on the beach, as heavy haul trucks or mobile service stations – thanks to their innovative uses, trucks are much more than just packhorses. Here's a brief truck tour of five continents.

— edited by Torben Schröder



## INNOVATION – BEARING TECHNOLOGY



**The huge wheels of dump trucks** being used in mining in Europe and around the globe contain numerous innovative bearing solutions from Schaeffler. They not only include extremely durable wheel bearings for the front and rear wheels but also complete bearing solutions for the motors and planetary gears which are integrated in the rear wheels (pictured above, right). The main bearings for the rear wheel, for instance, each feature two tapered roller bearings with a size of up to one meter in an O arrangement. This results in a compact design with high load-bearing capacity and stiffness that impresses with very long service life. For electric motors, Schaeffler uses current-insulated deep groove ball bearings and cylindrical roller bearings to avoid damage caused by passage of electrical current. These bearings have long re-lubrication intervals and are suitable for large temperature differences. The planetary gears of the dump trucks are primarily fitted with self-aligning ball bearings and cylindrical roller bearings. They have a high load-bearing capacity – in an extremely small assembly space. In addition, they feature narrow tolerances which, together with the specially selected bearing clearance, allow for uniform load distribution. Thanks to the utilization of cages specifically designed for this application, the high centrifugal forces can be effectively absorbed.





# TRUCKING

## GOOD LUCK MINERS!

*The iron door locks, the elevator begins its fast 500-meter descent. Down there, it's a different world. Neon light illuminates the room from which a maze of drifts and tunnels traverses the mine. It's warm, 25 degrees centigrade, and a smell of salt is in the air. "There's no salt corrosion because it's dry," says Volker Grzeschuchna. "But if you'd take the Jeep we're using down here back up, it would be rusty two days later."*



*Volker Grzeschuchna is in charge of M+E Technology at the European Salt Company in Bernburg an der Saale, Germany. As well as for the electrical systems he's responsible for the vehicle fleet. "Getting the new vehicles down here is a real adventure," he says. Three mechanics spent a week taking an MAN truck apart. Grzeschuchna: "The driver's cabin, the body and particularly the tri-axle chassis posed the greatest challenges. We were only successful on the third try." Once it was down in the mine, the vehicle was reassembled in another two weeks before being ready for its first mission.*





# FLYING DOCTORS



**Trucks with five of their brake cylinders missing and the only remaining one damaged – Jost Forchner and his team have seen a lot in Africa. The harsh conditions there are equally rough on people and hardware. The right spare parts? Hard to come by. For the truckers, this means having to improvise. That's where Forchner and his team from**

**the Mercedes-Benz Service Camp come in. “Our twelve-member squad is constantly on the move. We stop anywhere our expertise is needed and where the next qualified garage would take half a day or longer to reach,” he explains.**

Every year, the customer consultant from Stuttgart, Germany, spends several weeks traveling from town to town and customer to customer – through all of Central and East Africa. His colleagues from the Kenyan Mercedes-Benz sales and service partner DT Dobie are



part of his party. On the premises of companies operating large truck fleets, the experts check the technical condition of the trucks, provide on-site training to drivers and mechanics, and lend a helping hand with urgent repairs. And for the truckers on tour, the service camp may even pitch its tents directly alongside major traffic arteries. Putting vehicles that heat, dust, potholes and wear have taken their toll on back on the road, and especially so that they're safe again – for Forchner and his team, it's both a challenge and passion.



## INNOVATION – COSTS



**The continent is large, the infrastructure poor, and money in scarce supply.** In Africa, transportation necessity is the mother of invention. Remedy number one: importing trucks from Europe. But the situation can be remedied with local ingenuity as well, as the South African company SAMIL proves: trucks from Magirus-Deutz are converted for military uses. Even more inventiveness is demonstrated by the British company Global Vehicle Trust, which offers a flat-pack truck for local assembly that only costs about 10,000 euros (small picture).







## INNOVATION – EFFICIENCY



*A huge area and comparatively few towns that are days apart – but in spite of this adversity, road freight transportation in Australia has to somehow be ensured at the lowest possible costs. The idea: why use a large number of trucks to haul freight if only one will do the job? The solution is called a road train. It consists of a motorized vehicle towing several trailers and/or semi-trailers. This combination is not only more economical but also more environmentally friendly, as one tractor emits less carbon dioxide than the typically used number of tractors. The longest road train, consisting of a tractor and 122 trailers, reached a total length of 1,474.30 meters. So-called Longer Heavier Vehicles (LHVs) are being tested in Europe as well. Billed as Gigaliners, they're about 25 meters long, weigh 60 metric tons, and save up to 25 percent fuel.*





# THE SANDMAN



*The vehicle that ranger Peter Meyer steers across Australia's Fraser Island is a far cry from a production model. The driver's cabin from a truck and the body from a bus on its back – these are perfect prerequisites for a special purpose, which happens to be a pretty sandy one in this case. "Here on the beach, you have to constantly drive at high rpms, close to the red range," Meyer explains. "The sand gets into every little gap and crack. Saltwater and the salty air will ultimately destroy any engine."*

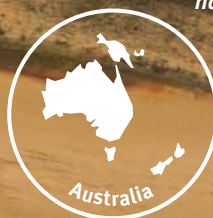

*The 44-year-old Australian with German roots offers sightseeing tours to visitors. 28 tourists can be seated in his self-built 280-hp vehicle to enjoy an exploratory tour of the island. He's never gotten stuck. "The right tire inflation pressure is crucial. I use 2.75 bar (39.9 psi) to increase the contact patch of the tires. That way, you practically float across the sand, not least thanks to all-wheel drive. On paved roads, something between 7.6 and 7.9 bar (110.2 and 114.6 psi) is typically used." New arrivals who think they know better may find themselves being rescued by Meyer: "They arrive in their expensive cars thinking that they're able to drive them anywhere and will ultimately dig themselves into the sand. I then pull them out again."*



# HARD WORK IN THE DESERT

*The place: Saudi Arabia. The mission: hauling a reactor from the Samsung factory on the coast in Dammam to a petrochemical plant in Shaybah in the south-east of the country. The challenges: this monster weighs more than a million kilograms, the distance to be covered is 1,080 kilometers, temperatures reach up to 50 degrees*



*centigrade, hills with gradients of up to eight percent are lurking on the way, and in some places the roads are merely seven meters wide.*

*The answer: ten trucks, two low-loading vehicles with a total of 64 axles, 18 specialists from Mamoet, a company specializing in heavy haulage, four escort vehicles, a sup-*

*port station, plus a mobile garage. On uphill stretches, the reactor is pulled by six trucks at the front and pushed by four at the rear, and on downhill sections, the combination is reversed: four in front, six at the rear. Setting up the reactor at the destination takes merely half a day. Mission accomplished? Far from it! A second reactor and many other parts that will also have to travel 1,000 kilometers are already waiting to start their journey.*





## INNOVATION – ALTERNATIVE POWERTRAINS



*The automotive industry didn't just start developing alternative powertrains yesterday in order to make its contribution to improving the global climate. Electric passenger cars have become established and some buses are powered by hydrogen fuel cells. The truck sector, however, particularly long-distance haulage, is still in an exploratory stage. But there's some progress to be reported in this area as well. It's of particular interest to the Asian marketplace, as numerous metropolises in the Middle and Far East rank among the top ten big cities with the poorest air quality. MAN recently presented the prototype of a tractor featuring a hybrid powertrain. The combination of a diesel engine (440 hp) and an electric motor (177 hp) could result in cutting carbon dioxide emissions by eight percent, according to calculations. A more concrete example, however, is the market launch of a tractor with a natural gas (CNG) engine. The 'TGM' model from MAN with a six-cylinder engine is said to become available before year's end. Natural gas will be the power source for heavy commercial vehicles in the near future, also according to a study by the German Automotive Industry Association (VDA).*



## INNOVATION – AUTOMATED DRIVING



***It does seem eerie:*** a Freightliner Cascadia truck glides across Highway 15 in the U.S. state of Nevada – and nobody has their hands on the wheel. The giant vehicle with 14.8 liters of displacement and 505 hp properly tracks all by itself. The delivery of this surreal spectacle is guaranteed by the so-called Highway Pilot System, consisting of front radar, a stereo camera, plus proven advanced driver assistance systems such as autonomous cruise control. In spring 2015, Daimler Trucks was the first company to receive road approval for an autonomous heavy truck – marking a major step on the road toward production level for this innovative technology. In addition to higher safety and efficiency, the truckers' performance capacity through reduced driver fatigue increases, according to research. These findings are highly valuable in the Americas where trucks are the most important means of hauling goods.





# ROMANTIC ALASKAN SCENERY

*"The Northern Lights in the sky put on a show that's so spectacular that it knocks me off my feet every time," says John Schenk. The 58-year-old truck driver regularly covers the distance from Fairbanks in Central Alaska to the oil fields at Prudhoe Bay in the Beaufort Sea in his truck:*



*twelve hours through uninhabited back country, at minus 50 degrees centigrade. Sounds grim, but isn't for Schenk.*

*After two hours on Elliott Highway, the man with sunglasses in his hair turns onto Dalton Highway. He travels the 670-kilometer distance twice a week. "But no trip is like another one," says Schenk who, after 35 years as a trucker, has some five million kilometers of driving duty under his belt. The highway takes him up and down across rolling hills. An oil pipeline alongside the road, with a shine as*

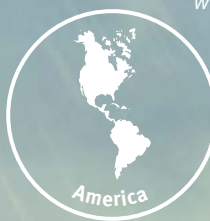

*silvery as Schenk's big bushy beard, seems like it was right out of a science fiction movie. Schenk's freight is destined for oil production as well: a dozen so-called rig mats, strong platforms placed underneath the oil rigs. A piece of cake for the 565-hp truck.*

*A cow moose with her calf on the roadside, unflustered by the huge truck, radio communications with oncoming colleagues, a stop at the Arctic Circle to take pictures – it's easy to guess why truckers like John Schenk love their job. It's sheer nature and adventure.*





# NO WAY FORWARD OR IS THERE?

— by Torben Schröder

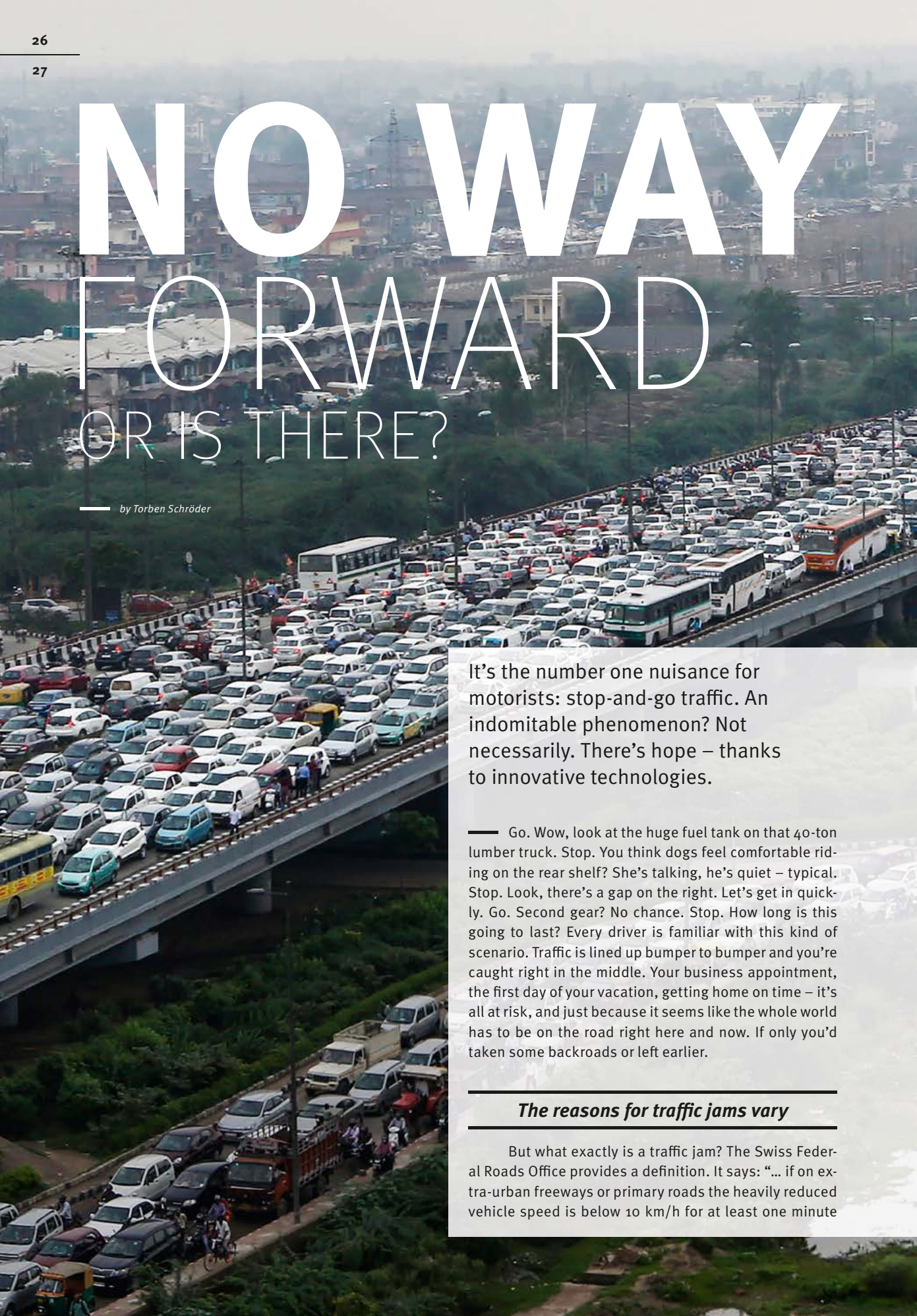

It's the number one nuisance for motorists: stop-and-go traffic. An indomitable phenomenon? Not necessarily. There's hope – thanks to innovative technologies.

— Go. Wow, look at the huge fuel tank on that 40-ton lumber truck. Stop. You think dogs feel comfortable riding on the rear shelf? She's talking, he's quiet – typical. Stop. Look, there's a gap on the right. Let's get in quickly. Go. Second gear? No chance. Stop. How long is this going to last? Every driver is familiar with this kind of scenario. Traffic is lined up bumper to bumper and you're caught right in the middle. Your business appointment, the first day of your vacation, getting home on time – it's all at risk, and just because it seems like the whole world has to be on the road right here and now. If only you'd taken some backroads or left earlier.

---

### *The reasons for traffic jams vary*

---

But what exactly is a traffic jam? The Swiss Federal Roads Office provides a definition. It says: "... if on extra-urban freeways or primary roads the heavily reduced vehicle speed is below 10 km/h for at least one minute





Every year, millions of pilgrims in and around New Delhi flocking to the Kanwar Yatra Festival cause huge traffic jams

and frequent stops occur.” In urban traffic, at hubs or bottlenecks on primary roads, the time lost would have to amount to a total of more than 5 minutes.

Two causes of traffic jams can be identified: lower throughput and/or higher traffic volume. The reasons for either of these are diverse and every motorist is intimately familiar with them. Roadwork, accidents, rubbernecking, weather changes, complete closures, and ineffective behavior of road users result in lower throughput. This means that, given the same traffic volume, an imaginary checkpoint is passed by fewer vehicles. The typical throughput on a road is 1,500 to 2,500 vehicles per hour and lane. Obviously, it’s clearly less within a construction site. Traffic volume increases as a result of rush-hour traffic, the beginning or end of vacation periods, large-scale public events, and the ‘rotation’ of hotel guests on Saturdays in holiday resorts. This type of road network overload is created when the demand for space exceeds its availability. It’s the cause of about 50 percent of all traffic jams.

---

### ***Traffic jams as a national issue***

---

They’re a major nuisance. But traffic jams are much more than that, as the losses they cause to national economies range in the billions. In Germany, for

instance, two thirds of the working population use privately owned vehicles to commute, according to some projections. A study by the UK Centre for Economics and Business Research says that every German, on average, spends 38 hours in stop-and-go traffic per year. The related direct costs, such as higher fuel consumption, and indirect costs, such as loss of productive time, amount to 7.5 billion euros per year in the 22 biggest German cities. This is 509 euros per household. The figures the study has revealed for the United States are even more dramatic. From 124 billion dollars (about 115 billion euros) in 2013, the additional costs caused by traffic jams are projected to increase to 186 billion dollars (about 172 billion euros) by 2030.

This is a global issue that scientists, politicians, and psychologists are endeavoring to resolve. But are humans even capable of avoiding traffic jams? After watching the film about a traffic experiment conducted by Nagoya University you’re inclined to believe that they aren’t. A specified number of drivers, evenly dispersed, lines up on a circular 230-meter test track in bright daylight, with no obstacles in sight, and in fair weather. The test subjects have been instructed to drive at 30 km/h and all vehicles are to maintain the same distance from each other. Sounds simple – but, apparently, isn’t. Following an initially smooth flow, a couple of cars start losing their rhythm. The vehicles behind them have to

# TRAFFIC JAM RELIEF **MADE BY SCHAEFFLER**

**Traffic jams are nerve-wracking and a burden on the environment. Twelve billion liters of gasoline and diesel fuel per year are wasted as a result of congestion on German roads alone. With innovative components such as the E-Clutch, Schaeffler contributes to reducing this burden while enhancing driver comfort at the same time.**

Schaeffler has automated the mechanically or hydraulically actuated clutch. As a result, fuel-saving driving strategies can now be used even in vehicles with manual transmissions instead of being limited to automatic

transmissions as in the past. The E-Clutch incorporates three concepts which are stepped depending on the level of automation. The most cost-efficient variant, 'MTplus,' enables 'sailing' in which the engine is disconnected from the transmission, being either completely shut off or idling. In the 'clutch-by-wire' development stage, a pedal is still used to operate the clutch but there is no mechanical link between the pedal and the clutch anymore. The operation of the clutch is initiated by an intelligent actuator. Electronic Clutch Management (ECM) that completely eliminates a pedal takes this development

to an even higher level. A sensor provides the signal for clutch disengagement when the driver starts to change gears. Engagement follows automatically when the gear is selected. The ECM's high degree of automation offers good prerequisites for integrating an electric motor into the powertrain to handle the bulk of the work in driving situations where the combustion engine runs uneconomically. Consequently, the E-Clutch not only opens up new perspectives for manual transmissions, but may be paving the way into new markets and segments for hybridized powertrains as well.

## THIS IS HOW ECM WORKS

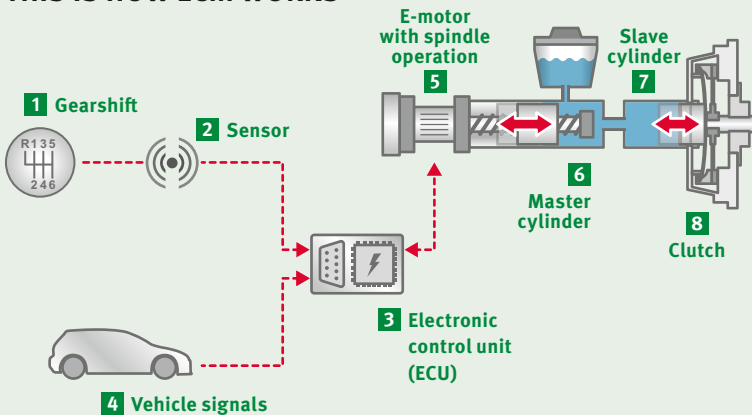

When the gearshift (1) is operated, a sensor (2) captures the signal for disengaging and engaging the clutch. In the ECU (3) the driver's shifting intention is analyzed together with other data such as vehicle signals (4). From this data, the required clutch torque is determined, adjusted via the e-motor (5) with spindle operation and, through its motion, transmitted via the master and slave cylinders (6/7) to the clutch (8)

## COMPARISON BETWEEN ELECTRIC CLUTCH SYSTEMS

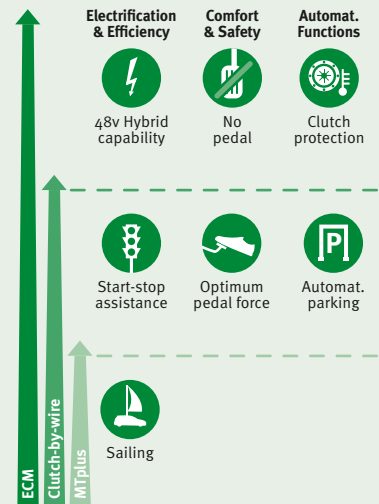

### SCAN THE CODE TO WATCH THE FILM

*A Japanese traffic experiment: would you have done better?*



brake and a traffic jam emerges out of nowhere. This so-called phantom traffic jam is a phenomenon every driver is more than likely familiar with in real-world situations as well. You creep along the freeway for minutes on end, wondering why traffic is not moving faster – and suddenly the congestion just dissolves. No roadwork, no accident, simply nothing that seems to have caused it. The reason in most cases, similar as in the Japanese test, is people following the vehicle in front of them too closely. If the driver of the preceding vehicle hits the brakes,



we'll hit them even harder, and so will the next driver, with a rippling effect. Hundreds of meters behind us, the first vehicle will come to a complete halt.

---

### ***People and technology can help***

---

“Be it in an experiment or in everyday traffic – sometimes traffic jams are simply inevitable,” says Prof. Dr.-Ing. Jürgen Krimmling, Director of the Institute of Traffic Telematics at Dresden University of Technology. “If roadwork is necessary, there'll be construction sites. When lanes narrow, drivers have no chance,” says Krimmling. However, any town or city, not least with assistance by its residents, could contribute to minimizing congestion. Krimmling: “Spatial equalization is one approach. It means showing motorists the fastest routes available to them. The entire road network of an urban area should preferably be used. The second approach is temporal equalization. Those who have the possibility to do so should not get on the road during normal rush hour periods. And a third possibility is to distribute people to the various means of transportation, in other words to motivate motorists to switch to bicycles or to use public transportation.” Plus – who would have thought it? – some traffic jams are even intended. “To relieve urban traffic congestion, for instance, the preferred approach is to let vehicles wait somewhere on the outskirts,” Krimmling explains.

As in many other situations in life, when it comes to preventing traffic jams, the animal kingdom is again a

step ahead of us. The flow of ‘traffic’ on ant trails, for example, is perfect. Researchers know why that's the case. These busy insects are less selfish than humans. Motorists think of nothing but themselves, not recognizing that their actions of speeding, tailgating or lane hopping always have an impact on many other members of their species. All of these are interference factors that can potentially cause traffic jams. Conditions in ant colonies, though, are even more crowded than those on our roads. However, that's not a disadvantage but an advantage. Ants communicate with each other using chemical signals. But instead of the individual striving to get ahead as fast as possible, all activities are centered on the colony.

Communication among road users: yes, all of us are familiar with it in the form of the finger or cursing at someone through an open side window. Communication to enhance efficiency, to strengthen the way we act together – that's something humans find hard to do. That's why we use help: from technology. Traffic news and navigation systems warn us of stop-and-go traffic and accidents, while electronic traffic control systems indicate the speed we should drive at whenever there's a risk of road overload. “When the signs light up saying ‘80 km/h,’ the purpose is not to make drivers angry, but an attempt to ensure optimum flow,” says Jürgen Krimmling. “If everyone heeds the advice, everyone will benefit from it: they'll be moving forward faster, although it seems that they're driving at a slow pace.”

Even more technological assistance is delivered by automated driving in which the human driver





assumes the role of a passenger and the vehicle the part of a 'brain.' In terms of preventing traffic jams, this is an absolute gain in Jürgen Krimmling's view: "Due to the automatic specification of the space between vehicles, there'll be less congestion and generally better traffic flow." One of these approaches is called 'Car2X-Communication.' Vehicles are interlinked with traffic lights and other traffic signals. As soon as traffic becomes denser with a risk of congestion, this information is communicated to the vehicles concerned, so they can avoid the area or adjust their route accordingly. "The vehicles are taught swarm behavior like that of ants which causes everyone to act in sync," says Prof. Dr. Michael Schreckenberg, chair holder of Physics of Transportation and Traffic at Duisburg-Essen University. "That way, vehicles on the freeway, for example, would all brake simultaneously and by applying the same force, or start moving again." This principle already works in theory and, according to Schreckenberg, is expected to produce initial success in practice in about five to ten years from now.

But what if you do get stuck – in a traffic jam? What should you do? Prof. Krimmling: "In case of a complete closure, my advice would be to keep cool by reading a good book. If you'd like to avoid congestion by taking a backroad, then don't turn left in the direction of the traffic jam because there you're likely to encounter another bottleneck. Instead, take the opposite direction. You'll find alternative routes there as well and taking a look at a good old map may definitely be helpful." But even in a case like this, technology may soon be able to assist. Together with TomTom, a Dutch producer of navigation products, Duisburg-Essen University is working on a solution that will indicate individual detours to drivers in order to equalize the traffic situation.

An all-new generation of traffic navigation is being developed by HERE. The online map service that was sold by Nokia to the German automobile manufacturers Audi, BMW and Daimler in summer 2015 combines high-resolution maps with local real-time information and, thanks to capturing billions of individual pieces of information, is supposed to provide customers with a realistic reflection of traffic conditions with accuracy down to a second. That would make 'looking-around the corner' possible for early detection of dangerous situations or traffic jams.

Welcome to the future. 

---

The U.S. metropolis Los Angeles is considered one of the world's most congested cities, according to numerous studies

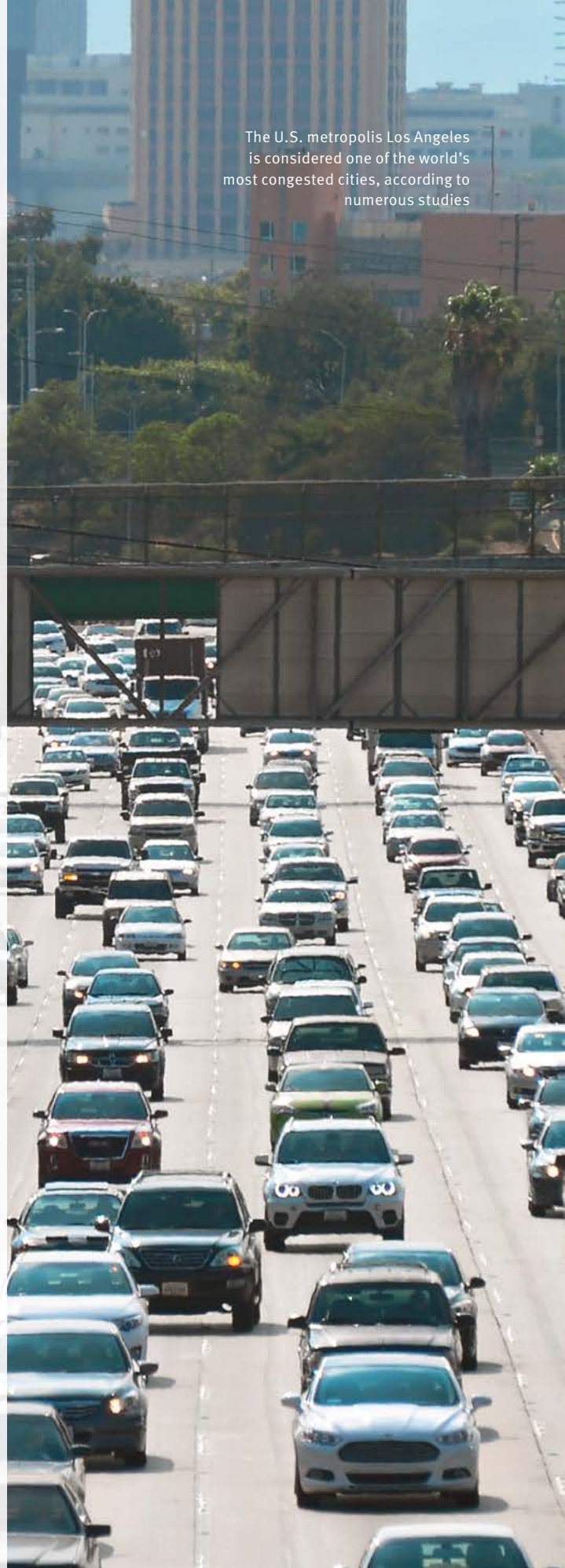



# THE TEN MOST GRUELING TRAFFIC JAMS IN HISTORY\*

## USA AUGUST 1969

*Half a million visitors leaving the Woodstock Festival near Bethel are paralyzing the New York Thruway for three days*

## FRANCE FEBRUARY 1980

*160 kilometers of stop-and-go traffic between Lyon and Paris. The reason for this unofficial European congestion record: people returning from the winter holidays, combined with bad weather*

## GERMAN- GERMAN BORDER APRIL 1990

*The first Easter weekend following the fall of the wall. Several million cars are traveling westward, according to police estimates. Normally, only 500,000 vehicles are on the road*

## JAPAN AUGUST 1990

*The end of the summer vacation and people fleeing an approaching typhoon. A dreadful combination for motorists on the highway between Hyogo and Shiga. The result: a 120-kilometer traffic jam*

## USA SEPTEMBER 2001

*Following the 9/11 terrorist attacks, New York City is hermetically sealed off. Bridges and tunnels may only be used by police and rescue vehicles. Even all aircraft are grounded*

## USA SEPTEMBER 2005

*Tens of thousands of Americans flee hurricane Rita in Texas, clogging Interstate Highway 45 across a distance of 150 kilometers for 48 hours*

## BRAZIL JUNE 2009

*That the most congested city also sets a congestion record is no wonder. A traffic jam nearly 300 kilometers long in São Paulo on June 10 due to bad weather and a holiday coming up*

## CHINA AUGUST 2010

*A highway between Tibet and Beijing is clogged across a distance of 90 kilometers. The vehicles causing the congestion include heavy tractor-trailers hauling material to the Chinese capital ... for road construction*

## USA FEBRUARY 2011

*Due to a massive blizzard, the road network in and around Chicago is completely paralyzed*

## RUSSIA NOVEMBER 2012

*For three days, motorists on the highway between St. Petersburg and Moscow are forced to spend the night in roadside tents due to a blizzard*

\* Source: Forbes-Magazin (in chronological order)



# BRUTISH, BRILLIANT, INNOVATIVE

Around 5000 BC, farmers used wooden hook plows to cultivate their land. These days, high-tech farm machinery works the fields.

— by Marco Kraft and Roland Zumsande



## THE TOP-SELLER

*In Western Europe almost one in every three tractors over 200 hp is a Fendt Vario. One explanation for the popularity of the model with an output of up to 517 hp is its reliability. Schaeffler plays a part in this. The supplier and the agricultural machinery manufacturer enjoy a long-standing partnership in development. Bearings from the*

*Schaeffler range are used throughout the entire drivetrain of Fendt's tractors – from the continuously variable transmission to the differential and the front and rear power take-off shafts to the rear axle. Several years ago, Fendt switched to Schaeffler X-Life bearings at the rear axle of its Vario 900-series. The high-quality bearings offer an even longer lifespan, a higher load capacity and a better use of space. By using the X-Life bearings in specific areas of the drivetrain, Fendt is able to authorize higher loads without changing the design – thereby increasing the range of applications.*



## THE REVOLUTIONIST

*The Module Express 635 from Case IH has revolutionized cotton picking. As a world's first, this cotton harvester now makes it possible to press the harvested wool into bales of several cubic meters while still moving and at the same time takes care of the primary packaging. Today, most manufacturers offer similar methods. The work involved for both producers and processors is significantly reduced. The harvesting machine of the American agricultural machinery manufacturer is powered by a 400+hp in-line six-cylinder 8.7 liter engine. Rows at a time, this machine sucks the cotton flocks through spindles at the front and plucks the soft, fluffy staple from the sensitive cotton plant. Through a cleverly designed vacuum air flow system, the crop is blown into a basket which can hold 4.5 tons, while removing impurities at the same time.*

## THE GARGANTUAN

*When 'Big Bud' revs all 16 cylinders of its V-diesel engine, the earth trembles. Unruly, loud, imposing; the world's largest tractor plows through the fields with 39 tons of dry weight. This massive farm machine is driven by 1,100 horses. 'Big Bud's' dimensions are equally as impressive: 8.23 meters long, 6.10 meters wide and 4.27 meters high. Since 1977, the gargantuan was used predominantly for harvesting cotton. Today, the Guinness Book record-holder, now owned by two brothers in Montana (USA), rarely ventures out on the fields. The price for one tankful being in the five-digit figure region and the complicated replacement of worn parts make the hurdles simply insurmountable, even for the wealthiest of farmers.*





## THE HARDEST WORKER

*The first sugar beet harvesters were still pulled by tractors over the fields. Totally low-tech, they laboriously plowed up every last beet. Today, harvesters such as the Tiger 5 from Ropa do all the work. With its lifting unit, the 32 ton harvesting factory on wheels can pull up to nine rows of sugar beet out of the soil and immediately feed them into the 43 cubic meter bunker. Once the Tiger 5 is on its trajectory, an automatic leveling system with sensors scans the soil and it drives itself. In the meantime, the driver can sit in the comfort of a fully-glazed panoramic cabin, concentrate on the harvesting process and make adjustments via a touch screen. A new hydraulic chassis system reduces the roll of the machine, automatically distributes the load and compensates on sloping ground.*



## THE GRUNTIEST

*According to the manufacturer, the Hanimax Soft is the strongest forestry machine in the world. The large timber harvester consists of a 50-ton crawler excavator, a five-ton harvester head and a gripper arm with a 15 meter reach – it plucks fully grown trees out of the ground as if they were flowers. With a hydraulic force of 30 tons, the two pincer arms grip the trunk that is to be pulled out. Afterwards the harvester processes the wood. Two rotating chainsaws delimb the trees and cut them into smaller logs.*





## THE MOST EFFICIENT

*Fertilizer spreaders may not look particularly spectacular from the outside. But hidden inside is some pretty sophisticated technology. The AXIS H 50.2 EMC+W from Rauch is the world's first fertilizer spreader that distributes manure and also automatically controls and monitors the dosage. A clear advantage aside from saving time is the cost efficient use of materials. Every four seconds, 27 radar sensors check and optimize the spreading pattern. At the same time, high-tech sensors – contact-free and within fractions of seconds – measure the drive torque of the spreading discs and automatically adjust the fertilizer flow depending on the driving speed. The torque measuring modules are supplied by the Schaeffler product brand FAG.*





## THE MOST SENSITIVE

**Grapes are just as discerning as connoisseurs of the bottled grape juice.** Excellent wines can only be produced when everything runs smoothly with the harvest. The ERO-Grapeliner 6000 has everything to ensure the optimal harvesting of every variety of grape. This machine is the first harvester in the world to combine an unloading conveyor with a de-stemming system and sorting table. Moreover, ERO is the only manufacturer to offer automatic steering ex-works. Drivers can devote their full attention to the harvesting unit. For added safety, two cameras and an ultrasonic height sensor indicate the distance between the harvesting head and the ground.



## THE SPORTIEST

**Tractors usually set a leisurely pace when plowing the fields.** With Tractor Pulling, however, things shift up a gear or two. Here, the powerhouse pullers pit themselves in motor sport. Some of these tractor pullers can produce over 8,000 horsepower. The name of the game is 'full pull.' A sled with a movable weight has to be dragged over a distance of 100 meters. Thanks to powerful and innovative components

from the product range of the Schaeffler Group – like high performance clutches from LuK – the tuned tractors can transfer unimaginable power to the muddy tracks. So far five German championships, a European title and one Eurocup victory were clinched with Schaeffler know-how.



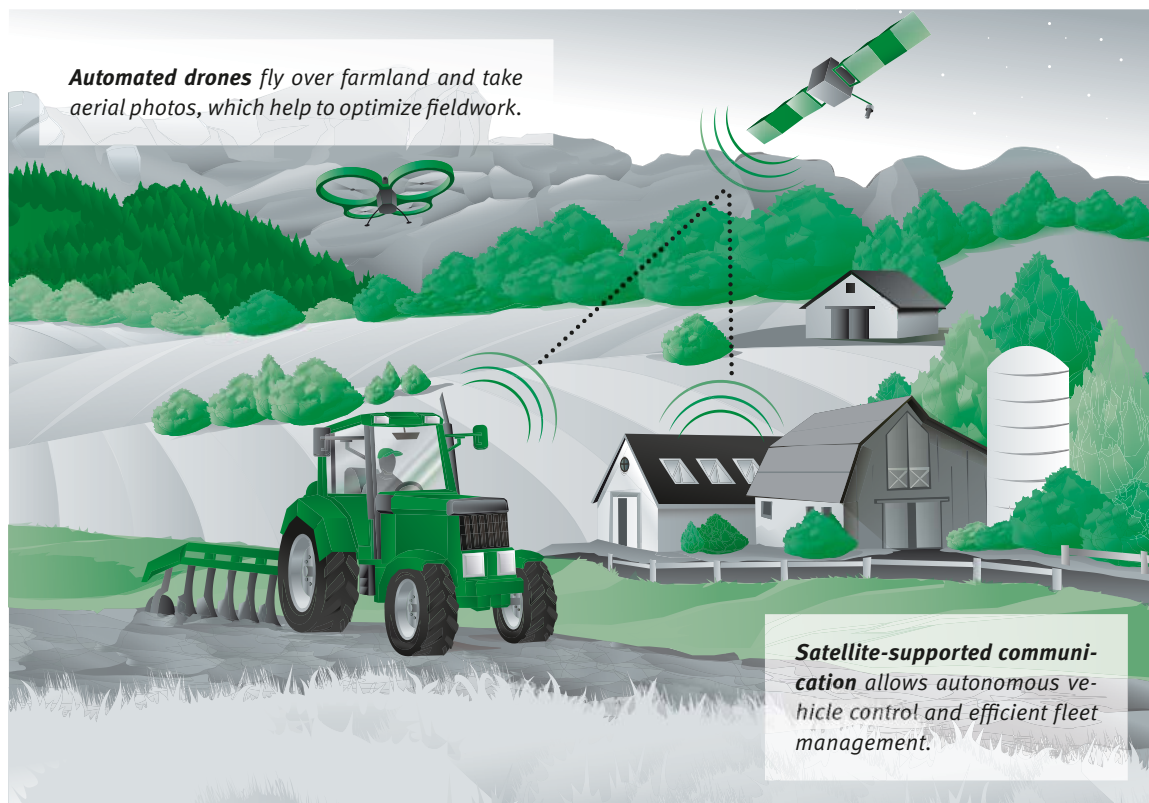

**Automated drones** fly over farmland and take aerial photos, which help to optimize fieldwork.

**Satellite-supported communication** allows autonomous vehicle control and efficient fleet management.

## HIGH-TECH IN THE CORNFIELD

**Drones, sensors, GPS and apps: Agriculture today uses cutting-edge technology, which is both comprehensively networked and smart.**

### **Paparazzi in the field**

Equipped with digital cameras, nimble drones are one of the latest accomplishments in agriculture. They give farmers a totally new perspective – from the air. The advantage: aerial shots help detect damage caused by pests, drought or storm. Plus, other problems such as faulty drainpipes are easier to detect. A special talent for steering multicopters is not necessary. An app establishes the target areas on a map and automatically calculates the best flight path. The route is transmitted to the drone, which then takes off on an autonomous reconnaissance flight. At regular intervals, the drone photographs the fields and saves the

GPS data of the recordings. The photos are then compiled in a computer to form a map.

### **Directions from space**

Satellites provide backup even from higher spheres. While the engineers in the automotive industry are still working on roadworthy, self-driving cars, farmers have long been chauffeured over their fields. Controlled by GPS satellites, tractors and harvesting machines including trailers move autonomously and perform exacting farm work. With no overlap, this saves time and money. The farmer goes along for the ride and can either keep an eye on the instruments or work on a laptop.

### **Self-propelled data centers**

High-tech for farming doesn't just come from dizzying heights. Sensors in the floor of the machinery ensure

that fertilizer can be adjusted virtually in real time. An example: nitrogen sensors on the front of the tractor can determine the crop condition via light waves and give the computer in the cabin a fertilizer recommendation. This then informs the towed fertilizer spreader of the optimal amount to distribute. Parallel to this, the digital tillage maps and geo-data stored in the onboard computer determine nutrients that are missing in certain areas. Every square meter receives the ideal amount of fertilizer.

### **Smart farming at a glance**

To keep track of the amount of data, providers such as 365 FarmNet offer digital platforms where farmers can analyze their pooled data. In addition, farmers can download settings for agricultural machinery, find weather information and get recommendations for seeds and pesticides.



Handwritten notes in a cursive script, possibly a foreign language, located at the top of the page.

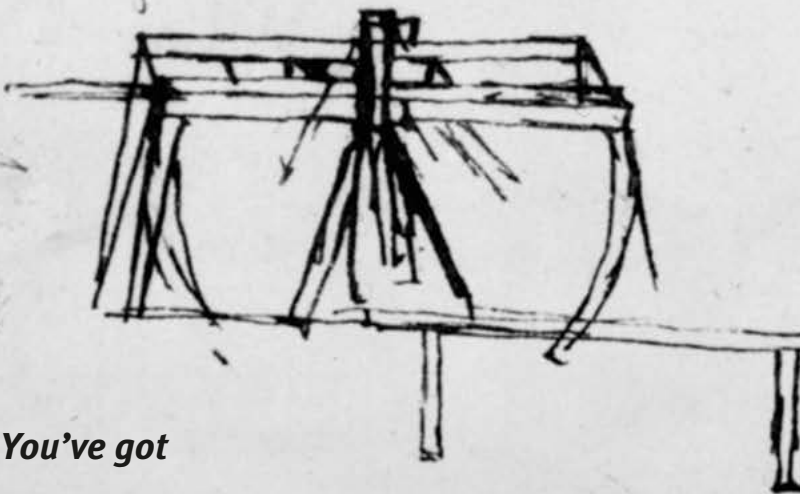
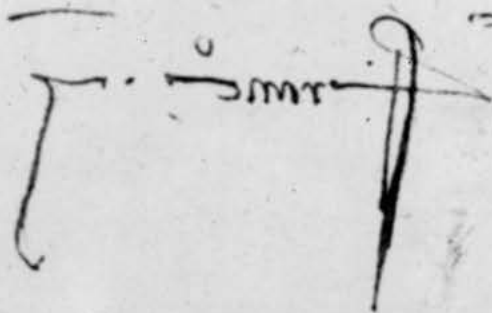

**» Stay hungry, stay foolish! You've got to find what you love** Steve Jobs

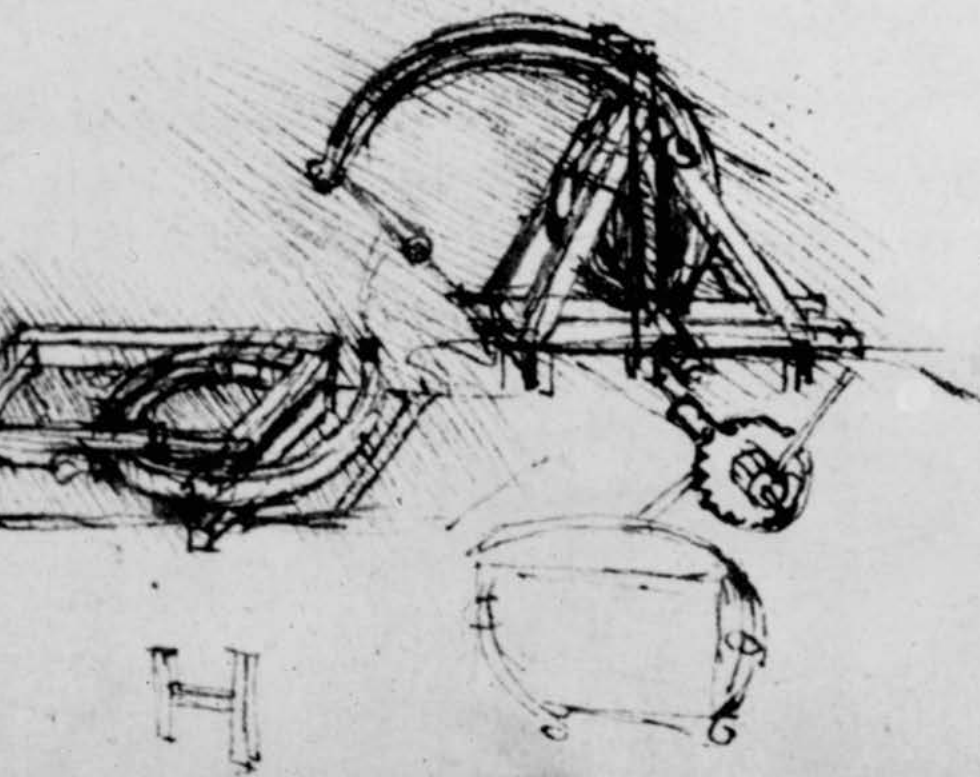

57

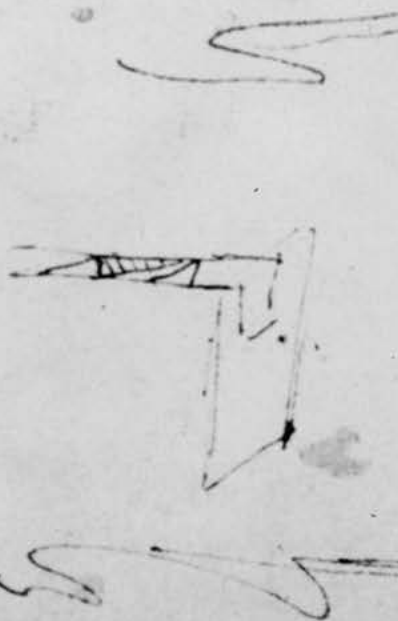



A collection of Leonardo da Vinci's sketches for a perpetual motion machine. The central sketch shows a large wheel with a complex internal mechanism of gears and levers, mounted on a wooden frame. Other sketches around it show various components, including a gear-like wheel, a vertical shaft with a hook, and a horizontal beam with a weight. The sketches are drawn with dark ink on aged paper, showing the characteristic overlapping and scribbled lines of Leonardo's work.

# in motion

Innovations in the course of time

## UNFULFILLED DREAM

— To keep a device moving eternally without using an external energy supply: in Latin it's called *Perpetuum mobile*. For more than 1,000 years, inventors have endeavored to create such an apparatus. One of them was Leonardo da Vinci. But his attempts never made it past the drawing board (photo). He recognized and calculated that mechanical perpetual motion belongs in the realm of the impossible. And he's still right today. Well, the innovation-driven da Vinci was much more than 'just' the painter of the famous *Mona Lisa*. Born in the 15th century, the Italian performed pioneering feats in the fields of cartography, optics and military equipment. The ingenious jack-of-all-trades also dabbled in engineering to such an extent that many regard him as the greatest of all inventors. For example, he was the first to draw the forerunner of today's rolling bearing.





# SHIFTING IN VARIOUS WAYS

Mobility of tomorrow – in automotive engineering, this not only implies a growing diversity of concepts in engine technology. The variety of transmission systems has significantly increased in recent years. Schaeffler offers innovative system solutions for all types of transmissions – space-saving, durable, and friction-optimized.

— by Jan Horst





— Engineers in the field of transmission development are challenged to employ the gift of foresight because, in addition to the growing number of technological solutions, a great diversity of consumer habits around the globe has to be taken into account in their work. Amidst conventional automatic transmissions with torque converters, dual-clutch transmissions, continuously variable transmissions (CVT), and automated manual transmissions, the traditional manual transmission appears almost anachronistic. In fact, it has been coming under increasing pressure due to various requirements. However, in Europe, South America, and

Asia, it by far continues to be the most important type of transmission, especially in price-sensitive vehicle segments. Schaeffler has developed strategies to make the diverse transmission concepts – including the ‘manuals’ – fit for the future.

---

### ***New standards call for new strategies***

---

A manual transmission, due to its less complex design, has clear cost benefits compared with an automatic transmission. Its high efficiency even provides



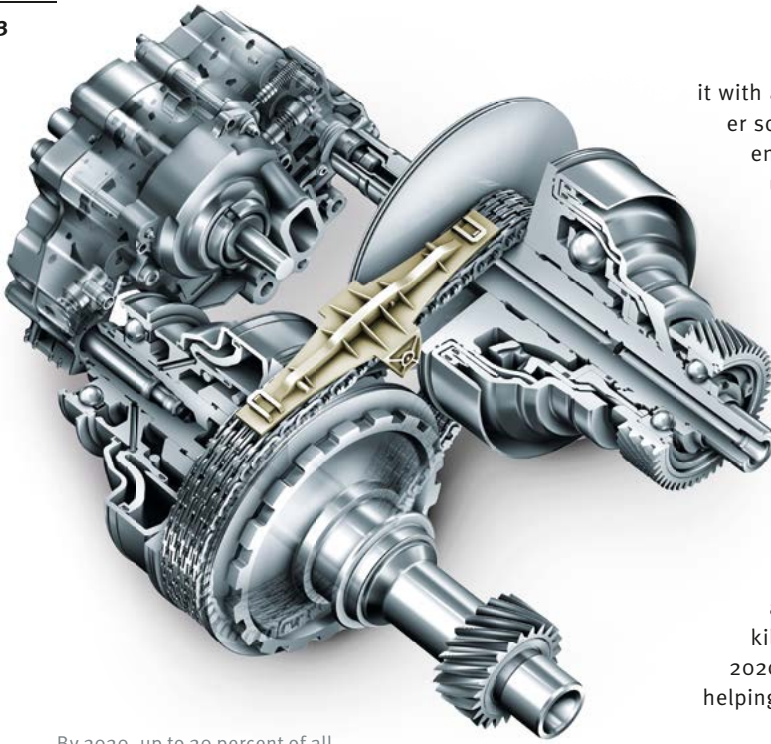

By 2020, up to 20 percent of all automated transmissions will be CVT types. Schaeffler's portfolio includes products such as plate sets, plate link chains, and hydraulic components

In Schaeffler's integrated torque converter, the clutch function is performed directly via the converter turbine instead of using a separate piston. This makes it possible to also use innovative absorption concepts such as a centrifugal pendulum-type absorber

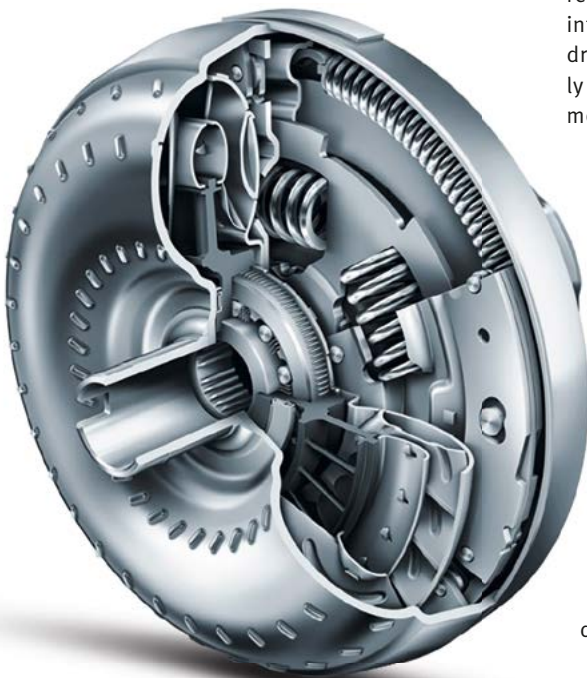

it with advantages in direct comparison with other solutions – its simple gear sets require less energy. In spite of these benefits, the manual version has come under pressure. The reason is that, beyond the aspect of efficient power transmission alone, fuel-efficient driving strategies have long become important in the light of constantly growing environmental and climate protection requirements. And these strategies can best be achieved through higher levels of automation and electrification – energy recuperation, 'sailing' (coasting) or start-stop systems point the way forward. The requirements are tough. Since 2015, fleet emission standards in Europe have set a limit of 130 grams of carbon dioxide per kilometer, to be lowered to just 95 grams in 2020. Every gram matters and Schaeffler is helping achieve these reductions.

Another challenge arises from engines using less and less cylinders or cylinder deactivation systems. They reduce consumption but are conducive to irregular crankshaft rotation resulting in vibrations that impair comfort. Torsion dampers such as the Dual Mass Flywheel (DMF) and the Centrifugal Pendulum-type Absorber (CPA) by Schaeffler's LuK brand help absorb such vibrations. Over the long run, absorption systems with even higher performance levels that Schaeffler is currently driving forward will be in demand.

In the field of manual transmissions, Schaeffler's transmission specialists are expecting an upgrade to result from partial automation. Fuel consumption is intended to decrease and comfort to increase due to drive-off or traffic jam assistants. This isn't primarily about the transmission but about automating the module in front of it – the clutch. Schaeffler has developed three stepped concepts of an E-Clutch, in other words an electrically operated clutch. The MTplus variant uses the existing hydraulic actuator. This reduces costs. For example, the system disengages the clutch when the driver lifts. This 'sailing' or coasting mode will result in fuel savings of two percent in the future WLTP test cycle when the engine is idling, and even up to six percent when the engine is shut off. The second stage, Clutch-by-wire, no longer relies on a mechanical or hydraulic release system but on an electric actuator. This system enables highly dynamic interventions, for instance in speed-shifting or sudden braking events. Finally, when using Electronic Clutch Management (ECM), a clutch pedal can be completely omitted. When the driver starts shifting, a sensor supplies the signal to



disengage the clutch. This solution also makes it possible to integrate an electric motor into the powertrain for mild hybridization. As a result, not only the number of options available for manual transmissions increases but hybridized powertrains are finding their way into new markets and segments.

---

### ***Solutions for small vehicles***

---

The automated manual transmission is another technological solution besides conventional manual types. It became in vogue in the 1950s ('Sportomatic,' 'Saxomat') and, starting in the 1990s, was used on a larger scale in small cars such as the Renault Twingo, Opel Corsa, and Smart. This solution is based on a conventional manual transmission but features partially automated disengagement/engagement of the clutch and shifting. However, a major breakthrough into higher vehicle classes is prevented by an undesirable interruption of power which notably impairs comfort.

In the field of automatic transmissions, in addition to the established multi-ratio transmission, as the classic, multi-speed planetary transmissions with torque converters are called, and the continuously variable transmission (CVT), dual-clutch transmissions have established themselves. This variant featuring two clutches has been recording major growth particularly in Europe and China. In 2025, every fifth automatic transmission is expected to be a dual-clutch type. For hybrid powertrains, Schaeffler has developed solutions for hybridized dual-clutch transmissions. The connection of an electric machine, by means of a booster function and without requiring any additional components, enables all hybrid functions such as engine start/stop and recuperation of braking energy, as well as downsizing of the internal combustion engine.

With classic planetary automatic transmissions, there is a trend toward a growing number of gear ratios. There are several reasons supporting this trend. The smaller gear ratio spread leads to more comfortable, softer, and hardly noticeable shifting events. Furthermore, fuel consumption and emissions drop by several percentage points with each additional gear as the engine can consistently operate in the range of the map that is ideal for fuel economy. Schaeffler contributes its

expertise in many areas, such as in the complete bearing package for shafts, gears, and planetary gear sets. In roller bearing technology, the company's portfolio includes an axial needle bearing for planetary gear support that can reduce carbon dioxide emissions by as much as one gram per driven kilometer – at additional costs of less than ten euros.

For transmission manufacturers, the growing number of gears entails additional design requirements. To utilize the forces and torques from the gear ratios, the axial distances between the planetary gear sets increase. These distances, combined with rotational speeds, influence the centrifugal force load acting on planet carriers, planet wheels, and bearings. Currently used manufacturing methods allow for bearing loads up to 3,500-fold force of gravity. However, in the latest automatic transmissions, future acceleration will increase up to 8,000 *g*. For comparison: during a carousel ride, about 4 *g* act on the human body, an ejection seat in a fighter plane accelerates a pilot's body up to 25 *g*. If the needle roller of a planetary wheel bearing weighs one gram, acceleration by 8,000 *g* results in a weight force of about eight kilograms.





# GLOBAL MARKET SHARE TRANSMISSIONS

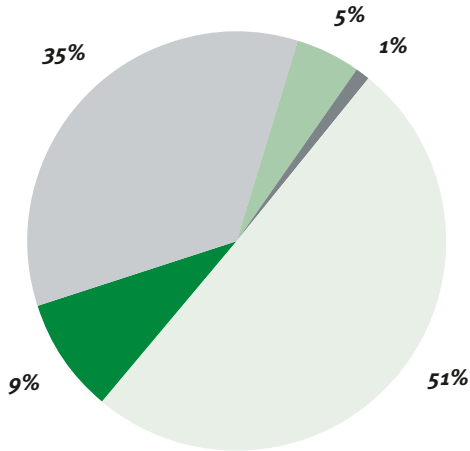

- *Continuously variable transmissions (CVT)*
- *Automatic transmissions*
- *Dual-clutch transmissions*
- *Automated manual transmissions*
- *Manual transmissions*

As of 2013

## Reducing resistances

To design automatic transmissions for even greater efficiency, Schaeffler contributes developments to several areas. Investigations have revealed that an improved planetary wheel bearing

ing cage construction can enhance friction behavior by up to twelve percent. An optimized coating of the cage reduces resistances by up to 23 percent, and weight-optimized planetary wheels even by up to 50 percent. Multi-plate clutches in the transmission and the torque converter offer further optimization potential.

Continuously variable transmissions have been around for quite a while as well. Together with Audi, Schaeffler launched the first continuously variable transmission (CVT) that is suitable for powerful engines in the torque range of up to 400 Nm (295 LB-FT). Continuously variable transmissions of this type deliver fuel economy advantages in partial load operation, lend themselves to combination with hybrid elements, and can be cost-efficiently produced. In combination with torque converters, modern damping systems, and hybridization, they guarantee high levels of comfort. CVT transmissions easily support the trends of downsizing engines and downspeeding the transmission of power. The most recent chain generations enhance torque capacity, enable wide spreads, and reduce weight and inertia as well.

No matter how multi-faceted the future of power transmission will be – Schaeffler offers a multitude of cutting-edge solutions that help improve the climatic and environmental footprint, and enhance everyday comfort at the same time. —





## “A WHOLE HOST OF CHALLENGING TASKS”

**Let's talk about transmissions. An interview with Norbert Indlekofer, CEO Automotive of Schaeffler AG.**

**— In the field of automotive transmissions, the variety is greater today than ever before. What does this mean for Schaeffler?**

There's no single global trend when it comes to consumers' preferences. And when purchasing patterns differ in various markets, we have to position ourselves as a manufacturer in a way that allows us to cover all wishes. We offer solutions for classic manual transmissions just like for CVTs, which are in high demand in Asia, for which we continuously improve the link-plate chain and other modules. For CVTs, we enable higher efficiency levels to be achieved due to our bearing technologies and improved torque converters. Furthermore, we offer dry and wet dual-clutches. Some solutions can also be combined with mild hybrid powertrains and start-stop systems have been finding their way into automobiles as well. This results in many new opportunities.

**How does the breadth of your product range change as a result of these requirements?**

Originally, INA supplied needle bearings and today our portfolio encompasses a wide variety of components such as release systems, facings, shifting units, starting elements, mechatronic assemblies for automation, converters, and even hybrid modules. Furthermore, the extension of our capacities and know-how in the field of facing technology has resulted in the Schaeffler Friction Products business. This pays off particularly with dual-clutch technology because the clutch facing makes a key contribution to

shifting comfort and reliable torque transmission.

**In the field of automatic transmissions, there's a trend toward an increasing number of gear ratios. What does this mean for you?**

Eight- or nine-speed transmissions are already in production and ten-speed transmissions are currently being tested in the field. Increasingly wider spreads require sophisticated ideas for vibration isolation in order to enable a comfortable noise level to be achieved. At the same time, requirements for bearing technology are increasing – both in terms of centrifugal forces and thus durability, and with regard to efficiency. Here, Schaeffler is presenting cutting-edge solutions that entail significant improvements – such as the most recent generation of small axial needle bearings in the planetary gear sets.

**The trends in automotive engineering are toward downsizing of engines, deactivation of cylinders, and downspeeding of power transmission systems. What challenges to Schaeffler arise out of these trends?**

A whole host of challenging tasks arises out of them, especially in the field of power transmission. Objectives like these are hardly achievable without vibration absorption. In the dual mass flywheel and the centrifugal pendulum-type absorber, we're currently offering two highly competitive solutions but future requirements will be increasing so significantly that we're obviously looking for further solutions. Additionally, smaller internal combustion engines promote the level of hybridization, while the level of efficiency and a vehicle's weight are further cornerstones of the efficiency strategies pursued by automotive OEMs. This challenges us to offer integrated, compact, and cost-efficient system solutions.





# INVENTIONS – POWERING PROGRESS

It's hard to imagine what our world would look like today without age-old inventions: no vehicles without the wheel, no sedentariness without agriculture, and no industrial revolution without the steam engine.

— by Andrea Neumeier

2.6 MILL  
YEARS  
AGO



## STONE TOOL

*Early humans found and used sharp stones. Later, they started working on stones and refining the tools. This was the very first human invention.*

1.4 MILL  
YEARS  
AGO



## CONTROL OF FIRE

*Fire paved the way into civilization for early humans. They could use it to warm themselves and to prepare meals, but it also served to clear woodland, and to scare away predators.*



# CLOTHING

## CLOTHING

To protect themselves against the cold, wind, rain, and injuries early humans used leaves and the hides of the animals they killed. Later, clothing became a sign of social status, wealth, and religious faith.



## LUNAR CALENDAR

The oldest lunar calendar in the Lascaux caves in France shows the lunar cycle in dots arranged in rows. It primarily served religious purposes and was the first way of making time measurable.

# SHIP

## SHIP

The first boats made from animal hides made it possible for humans in search of food to travel farther. As the first vehicles in the history of mobilization, ships helped transport larger goods across long distances.



400,000  
YEARS  
AGO

AROUND  
20000 BC

AROUND  
15000 BC

AROUND  
10000 BC

AROUND  
8000 BC

AROUND  
6500 BC

## BOW AND ARROW

Shooting arrows with a bow made it possible for humans to kill animals beyond their normal throwing distance. The bow as the first precise weapon was also the first device to store energy.



## OIL LAMP

Light at night: the simple oil lamp made it possible for humans to see at night for the first time. But it was also a decorative artifact and had symbolic power at feasts and ceremonies.



## MAP

The oldest cartographic paintings were found in Turkey and date to 6500 BC. They depict houses and a volcano. They marked the beginnings of surveying the world and depicting the environment.





### GLUE

**Glues** made from plant sap served to repair cracks in pottery vessels. Today, countless everyday items contain adhesives or are glued – from books to product packaging.

AROUND 4000 BC

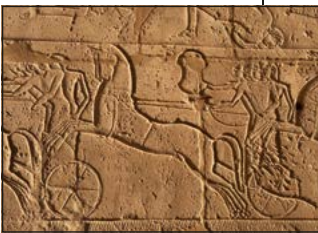

### WHEEL AND AXLE

**The potter's wheel and sleds** led to the development of the wheel and axle. The first wheels were rough wooden disks that helped transport heavy loads. The wheel is one of the most important inventions.



### CUNEIFORM SCRIPT

**The Sumerians** in Mesopotamia invented the first system of writing after they had previously introduced husbandry which laid the foundation for the first civilization.

AROUND 3000 BC



### ANESTHESIA

**Many medical innovations** wouldn't have been possible without pain control. The Egyptians discovered the pain-relieving effect of opium and the Assyrians used a mixture of belladonna, cannabis, and mandrake root.

AROUND 2000 BC

## STEEL

**In East Africa**, in 1500 BC, the first steel was produced in smelting furnaces. The alloy of iron and 0.2 to 0.4 percent carbon hardened the metal.



AROUND 1500 BC

### MAGNETIC COMPASS

**The Chinese** discovered that magnetite is magnetic. The first compasses still served magical purposes. Another thousand years would pass before they were used for navigation.

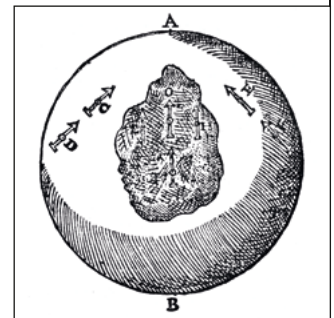

AROUND 400 BC



# HIGH-TECH BY SCHAEFFLER



*In 1883, Friedrich Fischer designed the first ball grinding machine that ground large volumes of hardened steel balls smoothly and with precision. Thanks to this innovation of the 'Kugelfischer' ('Kugel' means ball in English), the FAG brand became successful.*

*Today, Schaeffler roller bearings are being used around the globe. The latest invention is multi-row tapered roller bearings from the new Schaeffler Mancrodur high-performance steel that clearly extends service life. The bearings used in steel mills are thus better able to resist the high loads of forces, speed and shocks acting on them in harsh ambient conditions.*



AROUND  
200 BC

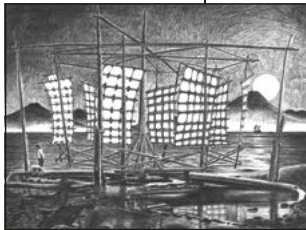

## WINDMILL

*On the first windmills, the airstream powered wings made from plaited reeds that were attached to a vertical axis the rotation of which was transferred to grinding stones. They were only followed by windmills with horizontal axes in northern Europe in the 12th century, the predecessors of today's wind turbines.*

AROUND  
40 AD

## BALL BEARINGS

*A cost-efficient method to reduce friction and energy loss between the rolling components of a mechanism is provided by ball bearings. In the remnants of two ships of the Roman emperor Caligula discovered in 1930, ball bearings of wood and bronze were found. Prior to this discovery, Leonardo da Vinci (1452–1519) was regarded as the inventor of the ball bearing. Friedrich Fischer (see box above), by inventing the ball grinding machine (1883), made the first industrial mass production of ball bearings possible.*



AROUND  
105 AD



## PAPER

*A messenger of the Chinese emperor created the first paper using wood fibers, grain stems, and bark. The fibrous sheet was easier to write on than wood and bamboo.*



## AUTOMATED DEVICES

*The predecessors of today's industrial robots were a boat with four mechanical musicians and a music box in the form of an elephant designed by the Arab engineer al-Dschasari.*



## PRINTING PRESS

*Printing shops existed in East Asia as far back as in the 8th century. But only Johannes Gutenberg's metal movable type made it possible to quickly mass produce printed materials.*

## STEAM ENGINE

*Thomas Newcomen invented the first steam engine to pump water from mines. It provided the basis for James Watt's (1736–1819) double-acting steam engine.*

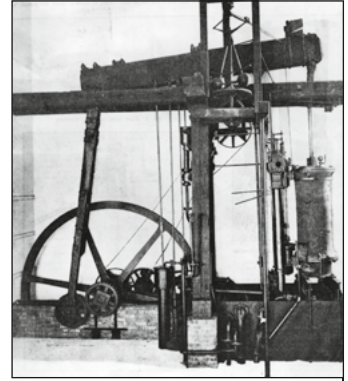

AROUND  
1200 AD

AROUND  
1300 AD

AROUND  
1450 AD

1709

1712

## CRANKSHAFT

*Al-Dschasari was also the engineer to develop the first crankshaft. It transformed linear motion into rotary motion and was designed to pump water from springs for irrigation.*

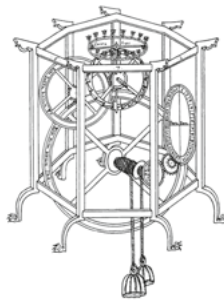

## WHEEL CLOCK

*Life in medieval times was controlled by a large number of bell signals from the church steeples and city towers. The first mechanical clocks were used as church clocks.*

## SMELTING OF HARD COAL COKE

*Iron producer Abraham Darby built the first coke-fired blast furnace. The use of coke instead of wood made larger furnaces possible and thus cheaper iron production.*





## HOT AIR BALLOON

*The Mongolfier brothers were the first to conquer the skies: they started the first manned flight in a hot air balloon near Paris. The brothers, however, did not understand yet what causes uplift.*

1783

## PUNCH CARD

*Joseph-Marie Jacquard pioneered the utilization of punch cards to control a fully automatic loom. The presence or absence of holes changed the movements of the loom.*



1801

## LIGHT BULB

*Even before Thomas Edison filed a patent application for his incandescent light bulb, the Scotsman James Bowman Lindsay demonstrated a constant, light-generating electric current.*

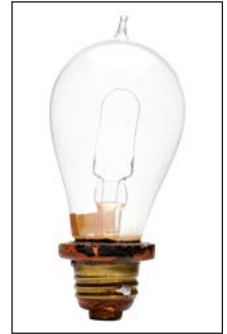

1834

1835

## GAS TURBINE

*John Barber invented the first gas turbine that transformed thermal energy into rotational energy. Today, gas turbines are primarily used for power generation or as jet engines.*

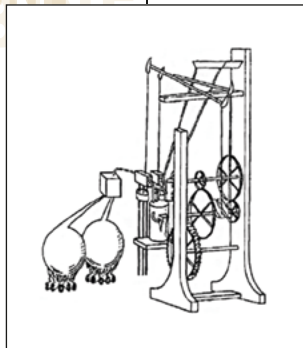

## SEWING MACHINE

*The first sewing machine with two bobbins was invented by Walter Hunt. It initiated the transformation from manual to industrial production of clothing.*







## REINFORCED CONCRETE

*The composite material consisting of concrete and rebar steel, invented by Joseph Monier according to a principle billed as 'an iron skeleton with a cement encasement' revolutionized civil engineering.*

## BICYCLE

*The 19th century saw important strides being made toward the development of the bicycle. John Kemp Starley presented a safety bicycle with two equally sized wheels. The bicycle was the first industrially produced mass mobility device.*



## COMPUTER

*Konrad Zuse designed the Z3, the first functional, fully automatic, program-controlled, and freely programmable Turing-complete machine: the first modern computer.*

1867

1876

1885

1886

1941

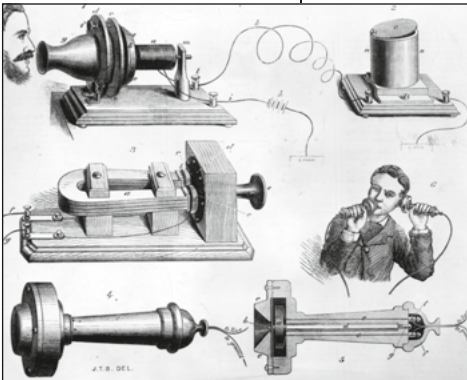

## TELEPHONE

*When Alexander Graham Bell was working on improving the telegraph he came up with the idea of not only transmitting Morse code but also the human voice.*

## AUTOMOBILE

*Carl Benz invented a motorized three-wheeled vehicle. A year later, Gottlieb Daimler and Wilhelm Maybach converted a horse carriage into a 'motor car.'*





## LASER

### LASER

**Laser beams** are electromagnetic waves. Albert Einstein already did research in this field. In 1960, Theodore Maiman produced the first laser – a ruby laser.

1960

## INTERNET

**ARPA researchers** developed a decentralized computer network in order to optimally use computing capacities. In the seventies, the ARPANET was renamed Internet and made accessible to the general public.



1969

# INNOVATIONS BY ACCIDENT

**Failures and happenstance can lead to success as well. Many important inventions were not intended.**

The discovery of one of the most important active pharmaceutical ingredients of the 20th century, penicillin, was accidental. On a day in 1928, researcher Alexander Fleming forgot to close a laboratory window. Fungal spores that entered the room destroyed the staphylococcus bacteria on his petri dishes.

Charles Nelson Goodyear accidentally dropped a piece of a rubber-sulfur mixture on a hot plate in 1839 – this mishap initially led to vulcanization and subsequently the rubber tire.



In a magnetic field experiment in 1945, the engineer Percy Spencer was standing in front of a radar unit for aircraft and surprised to see a chocolate bar melting in his pocket. He subsequently experimented with the radiation and other foodstuffs. The microwave had been invented.

A great innovation in medicine: Viagra was supposed to help against high blood pressure but the tests were disappointing. Instead, a side effect suddenly aroused the interest of the researchers: with many of the male trial subjects, the medication produced a potency-enhancing effect.



Automotive CEO Prof. Peter Pleus with a selection of vehicle models featuring Schaeffler innovations in the field of engine systems. The Chrysler 300C (in his hand), for example, used cylinder deactivation made by Schaeffler



“AUTOMOBILE  
MANUFACTURERS  
BENEFIT FROM  
OUR **EXPERTISE**  
IN ENGINE AND  
TRANSMISSION  
SYSTEMS”

Schaeffler has continually been accelerating automotive engineering with innovations for seven decades. A journey through time with Prof. Peter Pleus, Automotive CEO at Schaeffler.

— by Jörg Walz







— 60 Schaeffler products, on average, are currently installed in every new passenger car in the world: an impressive number. The product range extends from bearings to complete hybrid modules. The success story begins in 1949 when the brothers Georg and Wilhelm Schaeffler file a patent application for the cage-guided needle roller bearing that sets new standards in terms of frictional resistance, as well as durability and resistance to rotational speeds. Just a year later, the component has become an integral element in the design of the DKW F89. Mercedes-Benz and Adler-Werke use the innovation as well, followed by other automobile manufacturers.

### ***Bearings selling by the millions***

But why does this Schaeffler invention immediately conquer the market? Needle bearings previously consisted of a large number of rolling elements loosely arranged in grease. As a result, the individual rolling

elements rotate against each other. This, in turn, causes the bearings to overheat due to the resistance, which makes them unsuitable for higher rotational speeds. The cage is a game-changing technology, now precisely guiding the rolling elements that no longer work against each other.

From 1952 on, the cage-guided needle bearing is also a central component in the transmission of the Volkswagen Beetle and thus starts selling by the millions in practically no time. When Citroën introduces the avant-garde DS sedan in 1955, the stunned audience is left speechless. However, the road to mass production takes the Citroën engineers via Herzogenaurach once more because the transmission that originally used a plain bearing proved unsuitable for the high loads encountered at high cruising speeds on the autobahns that were still empty in those days. Schaeffler offers the solution to the problem in cage-guided needle bearings featuring a compact design and helps the aerodynamically

The BMW 525e (left) was the first car to have used the dual-mass flywheel. Today, automotive engineering is hardly conceivable without this absorption element between the engine and the transmission. In the Mercedes-Benz W116 the hydraulic lash adjusters make their debut in the new engine generation for the S-Class in the mid-seventies





INA needle bearings gave the Citroën DS (left) transmission stability and thus made it fit for autobahn use. The DKW F89 (center) was the first automobile to feature the innovative Schaeffler invention, and in the Ford Taunus 12M 'Cardinal,' tailored crowned bearings ensured a successful production launch. It was Schaeffler's first customized automotive product.

shaped front-wheel drive vehicle to be awarded with the "fit for autobahn use" quality mark.

The roller bearings, which are manufactured in numerous versions by the millions, help the company based in Herzogenaurach acquire profound expertise in metal forming as well. "Schaeffler sales engineers were always instructed to keep their eyes open when calling on customers," says Prof. Peter Pleus, Automotive CEO at Schaeffler. "And to always look at things from the perspective of the metal forming specialist. This way, other products that expanded the Schaeffler portfolio were soon developed." For instance, small retaining elements formed from metal for balls and springs that are required for the synchronization of transmissions and previously had to be inserted in the transmission in a tedious assembly process. "This eliminated a source of defects and minimized assembly costs," says Pleus.

---

### ***Precision in the micrometer range***

---

"And the road toward becoming a supplier of engine elements had its origins in metal forming technology as well," Pleus recalls. In the sixties, Schaeffler starts developing components for valve trains. In the mid-seventies, the hydraulic lash adjusters make their debut in the new engine generation for the Mercedes-Benz S-Class. They're based on bucket tappets that previously proved their prowess in the Porsche 917 Le Mans race car in harsh conditions.

"Manufacturing of the valve train elements by the millions requires utmost precision as these components are adjusted to each other in the micrometer range," Pleus explains, "and in addition to the production

capabilities, knowledge of the thermodynamic correlations in the engine is important too," adds the mechanical engineer who earned his PhD at the renowned ETH Zurich. Schaeffler progressively extends its portfolio of engine components over the years. Today, cam phasers (first used in the Ford Puma), switchable bucket tappets for cylinder deactivation (from 1999 on for Chrysler, Volvo and Porsche engines) as well as the world's first electrohydraulic fully variable UniAir valve control system that debuts with Alfa Romeo in 2008, and an evolution of which today is used in the models of several brands.

But the product portfolio not only extends across the cylinder head. In addition to various roller bearing

In the 959 high-tech laboratory, Porsche introduced a large number of technical highlights and innovations into this limited series. They included the hydraulic chain tensioner with which Schaeffler would subsequently also provide 911 drivers with a low-maintenance and durable engine







**»» Our sales engineers were always instructed to keep their eyes open when calling on customers. This way, other products that expanded our portfolio were soon developed**

Prof. Peter Pleus, shown here with Schaeffler concept cars used as test carriers for innovations

---



The rear differential of the BMW 1 is fitted with double-row ball bearings instead of the normally used tapered roller bearings. This reduces rolling resistance and as a result improves fuel economy

applications, such as the lightweight balancer shaft using a roller bearing (first installed in the Mercedes-Benz OM 651 four-cylinder diesel engine in 2008), it includes numerous components of the control and accessory drive – either with belts or chains – as well. Also included is the thermal management module that allows fuel consumption to be cut by up to four percent and was introduced in 2012 in the EA888 engine of the Volkswagen Group and in the Audi A5. Back in 1995, the generator freewheel celebrates its premiere, again with Audi, in the then fresh A4. This inconspicuous component decouples the belt from the irregular rotations of the generator. The compact component paves the way to success for the powerful diesel direct injection units and thus marks an important milestone in the development of efficient and high-performing internal combustion engines.

However, progress in engine design today is also achieved via the transmission – and vice versa. “Here, automobile manufacturers benefit from the fact that Schaeffler has expertise in engine and transmission systems,” says Prof. Peter Pleus. “This is unique in this form in the automotive sector.”

---

### ***Company founders set the course early on***

---

The course for it is set by Georg and Wilhelm Schaeffler in the mid-sixties by launching the LuK brand. The first product is a diaphragm clutch used in the more powerful four-cylinder models of Volkswagen and Porsche. It is followed in quick succession by other innovations such as the self-adjusting clutch or compact yet highly powerful torque converters that make the assembly space between the engine and transmission

a regular one for Schaeffler products. The invention of the dual-mass flywheel (DMF) adds a vibration absorber to Schaeffler’s offering in 1985 that has since become a standard component for efficient powertrains. It is used for the first time in the BMW 525e and celebrates its triumph in high-compression diesel units. Starting in 2010 – and debuting in the BMW 320d efficient dynamics edition – it is also combined with the centrifugal pendulum absorber that adds even more silence and smooth-running comfort to the powertrain.

The triumph of the dry dual clutch starts three years earlier. It is first used by Volkswagen but soon afterwards also by Renault, Ford, Fiat, Alfa Romeo, and other brands. Dual-clutch transmissions shift without power interruption and, featuring a dry design, are regarded as the world’s most efficient transmissions. Accordingly, the Schaeffler dual clutch is also used in the diesel-hybrid Volkswagen XL1, a “showcase model” for fuel economy.

The wide range of efficiency products also includes tandem ball bearings which in 2004 start to replace the traditionally used tapered roller bearings in the differential of the BMW 1. The double-row design of the ball bearing not only reduces friction but, in spite of identical load bearing capacity, enables a lighter-weight design of the rear differential.

---

### ***Concept cars underline competence***

---

That the whole, provided the right approach is used, sometimes has a greater effect than the sum of its parts is illustrated by the concept cars with which





Yesterday and tomorrow coming together today – the cage-guided needle bearings used in the Volkswagen Beetle soon cause sales to skyrocket. Other products are to follow soon. Schaeffler's LuK brand launches mass production of the diaphragm clutch in the mid-sixties. In quick succession, further Schaeffler technologies conquer the automotive world. In the Volkswagen XL1, for instance, the dry dual clutch system is used



**» Manufacturing of the valve train elements by the millions requires utmost precision as these components are adjusted to each other in the micrometer range**

Prof. Peter Pleus with an Alfa MiTo, the first vehicle to be equipped with UniAir fully variable electrohydraulic valve timing. Today, this innovative system is selling by the millions

Schaeffler has been attracting attention to its expertise ever since the unveiling of the CO<sub>2</sub>ncept-10% in 2009. Various production-based Schaeffler technologies are interlinked in these concept vehicles. "We used a clustering approach to various topics, be they related to electric mobility, hybridization, optimization of the internal combustion engine powertrain, or the diverse requirements in various regions of the world," Prof. Pleus explains. "In the Gasoline Technology Car, which in 2014 was unveiled based on a Ford Focus 1.0 and built in collaboration with Ford and Continental, the individual components would have resulted in improving fuel economy by 14 percent. Due to the interaction of the various technologies that was part of the design from the outset, fuel economy ultimately even improved by 17 percent."

The world's first electromechanical roll stabilizer celebrated its premiere in one of the concept vehicles as well. In the CO<sub>2</sub>ncept-10%, Porsche and Schaeffler are showcasing the potential of this component which, since 2015, started being used in top-of-the-range sedans and luxury SUVs. Another component that has been able to prove its prowess prior to its production



launch in one of the Schaeffler vehicles is the E-Axle that can be used in the drive systems of both hybrid and fully electric vehicles.

In the Schaeffler ACTIVEDRIVE that is based on a Škoda Octavia Scout, two of them are installed, each of them equipped with two e-machines and a light-weight differential. This enables wheel-selective power distribution with torque vectoring that is conducive to improving vehicle dynamics. “Due to the large battery, this vehicle tips the scales at more than one and a half metric tons,” says Pleus, “but thanks to torque vectoring, it can be driven on a vehicle dynamics course with the same agility as a clearly more compact car.”

Be it for e-vehicles or traditional automobiles trimmed for maximum efficiency: mechatronic actuators are further keys to achieving lower consumption and emissions. Unlike the previously used hydraulic systems, they only require energy on demand, in other words at the moment something is controlled or varied. Schaeffler has created an impressive modular kit for these purposes, containing actuators in the steering

system, cam-phasing, the clutch, ride leveling, and the aforementioned suspension stabilizer. “The list of products, application examples, and vehicles is much longer,” says Prof. Peter Pleus, “not only owing to the past because the technological challenges posed by mobility for the future are multi-faceted. And at Schaeffler, we’re perfectly prepared for them – always centered on innovation.”



## THE AUTHOR

*Cars for the road and the race track have been part of **Jörg Walz**' entire professional life, be it as a journalist, author of books, or press spokesmen for Alfa or Volkswagen. He is currently Vice President Communications and Marketing Automotive at Schaeffler. In this role, he also launched the 'tomorrow' technology magazine.*



# LEARNING FROM **STEAM** **LOCOMOTIVES**

A new drug against cancer, the self-driving car or the next killer application for smartphones: Everyone seems to have their own idea of what innovation is. But what are the prerequisites for being truly inventive? Those searching for an answer have to part with cherished certainties – and be able to cope with contradictions.

— by Claus Gorgs



— Wulf-Dieter Schmidt-Sacht had been expecting this rejection. “You’re destroying my life’s work,” his boss, Heinz Neumüller, the founder and CEO of Cewe, a photo services provider based in Oldenburg, boomed when his head of research, Schmidt-Sacht, presented to him his latest development shortly before the turn of the millennium: a self-service terminal to print out digital pictures on photographic paper. Today, a device like this can be found in any drugstore but, barely 20 years ago, it was a revolution – especially for a company that was making its money developing analogous films. Fearing that Neumüller might stop the project, Schmidt-Sacht had had the machine developed behind his back. A day after reading the riot act to him, the boss again summoned Schmidt-Sacht to his office: “When can you have the first 100 terminals ready?”

---

***Innovation is not plannable,  
but the right environment is***

---

Kodak, Agfa, Polaroid – the big brands of analogous photography have been swept away by the onslaught of digital transformation. In contrast, Cewe, with photo books, postcards apps, and online printing, is now generating more sales than in the heyday of color film. “Innovation is not always plannable,” says Reiner Fageth, a member of Cewe’s management board who succeeded Schmidt-Sacht as head of research. “But when new technologies start challenging your own business, the only

chance you’ve got is to spearhead the changing trend – and to never let go of your advantage again.”

The business cemetery is full of companies like Quelle, Grundig or Schlecker that clung to their old traditional business models and, ultimately, went out of business. As late as at the end of the nineteen-fifties, Krupp and Krauss-Maffei launched the best and most efficient steam locomotives of all time on the market – the idea of switching to diesel or electric power for trains, though, escaped them. Just a few years later, new competitors such as Siemens or AEG had revolutionized rail traffic, and not a single manufacturer of steam locomotives stayed in business. Former BMW CEO Norbert Reithofer once used the following example to illustrate the reason for pursuing his e-car strategy: “The most stunning steam locomotives were built at the end of their era.” The automotive industry, he added, would have to be careful not to fall into the same trap.

---

***Creativity and efficiency are a  
contradiction – but not always***

---

“Innovation and the structures of a large company are not really compatible,” says Jens-Uwe Meyer, CEO of Innolytics, an innovation consultancy based in Leipzig. Major corporations in particular are focused on efficiency and scalability whereas creativity and new ideas need freedom without immediately being put under





---

## »» *The most stunning steam locomotives were built at the end of their era*

Norbert Reithofer,  
former BMW CEO

---

profitability or cost pressures. To overcome this dilemma, he says, an innovation-friendly organization would have to be able to do both: optimize that which exists and, at the same time, try out new things. Therefore, innovative companies such as Schaeffler, Evonik or Cewe have been investing in creative laboratories in which employees, away from their routine daily business, are able to think out of the box (see report starting on page 72). Cewe executive Fageth hosts an innovation session every Monday morning which any employee is free to join. "Innovation is not a matter for the marketing or research departments, it's everyone's business," says the 51-year-old. A wealth of ideas has already been born or improved within this circle. "When 30 people take a look

at it and extract ten more flaws, you're ultimately going to have a better product," Fageth is convinced. The photo experts also periodically meet for brainstorming sessions with researchers from Offis, a university-affiliated institute for information technology. Internally, the company's employees have dubbed the all-day exchange of thoughts the 'crackpot round.'

---

### *Using start-ups without depending on them*

---

Working together with start-up companies that bring new market approaches or technologies to the cooperation is another way of tanking up on fresh ideas. Half the automotive world, for instance, from Volkswagen to Toyota, to General Motors, is currently vying for the technology of Mobileye, a young company from Jerusalem. The Israelis have developed image processing software that helps drivers to recognize critical traffic situations better and faster. This technology is an important element in the development of autonomous driving. "It would be reckless not to take advantage of the opportunities offered by the start-up scene," says innovation consultant Meyer. "However, this can only be a complement to a company's own innovation strategy."

The reason is that those who rely too much on others and don't trust their own ideas may ultimately suffer the same fate as Kodak. It was the U.S. photo corporation that, in 1978, had filed a patent application for the world's first digital camera – and subsequently shelved the plans. The risk to their own business model appeared too great to Kodak's executives. The future was to prove them right. —





## THE AUTHOR

*The Hamburg journalist and economist **Claus Gorgs** used to write for ‘Hamburger Abendblatt’ and ‘Wirtschaftswoche,’ and was head of an editorial team at ‘Capital’ and ‘Financial Times Deutschland.’*

*He used to indulge in an offline approach to life but now finds himself hardly ever leaving the house without his smartphone like most of us. His favorite innovation in recent years, however, has been the induction cooktop. Ever since he’s owned one, he enjoys cooking again – especially since the device really beeps only when it should.*







»» *Success is no accident. It is hard work, perseverance, learning, studying, sacrifice and, most of all, love of what you are doing or learning to do* Pelé



# here and now

Living with progress

## EYE ON THE BALL

— Technical innovations spur people to ever-greater heights. And sport is no exception. An example is the 'Footbonaut' (see photo), a robotic cage which soccer professionals use to improve their passing skills. With a price tag of around one million euro, only very few top clubs, like Borussia Dortmund, can afford the four-sided ball-feeding machine. Following the principle of chance, balls are fired at the player in the center, who then kicks them back to fields that randomly light up. It needs lightning reactions. The Footbonaut simulates the ever-growing demands placed on the players. Footballers have only a fraction of a second to call the shot. —



# ON A ROLL

Progress is like a transmission with many, many cogs. One drives the other. Every innovation relies on hundreds of others. And often behind the technical accomplishments is the name Schaeffler.

— by Johannes Winterhagen

— Carnival 1950. Germany is just starting to recover from the devastating effects of World War II. The last food stamps have been used, people once again have cash in their pockets. The fact that the economy is flourishing is thanks to many resourceful entrepreneurs, including Georg and Wilhelm Schaeffler, who founded an industrial plant in Herzogenaurach in 1946. However, in the everyday life of employees, serious shortfalls still predominate in many places. So, the management calls everyone together in the evening for a company carnival celebration. Georg Schaeffler and several employees are still deeply engrossed in the here and now: They are building the first prototype for a cage-guided needle roller bearing. When it is assembled a few hours before the party, Georg Schaeffler uses an ear trumpet to check that the bearing is working. His calculations made during a car journey several months earlier, pay off: If the ‘needles,’ as the long, cylindrical rolling elements are called, are not loosely inserted into the bearing, but are guided instead in a cage, thus preventing the roller elements from rubbing together, tilting no longer occurs. Friction losses due to the counter rotation are also eliminated. Thereby, such bearings can withstand significantly higher dynamic loads compared to the so-called ‘full complement’

roller bearings that are already a part of the Schaeffler range at this time. The subsequent eponymous industrial needle bearing ‘INA’ is born.

---

## *The invention tours Germany*

---

The world needs to know about a good idea. And so several weeks later, Georg Schaeffler and one of his engineers head off around Germany. For the presentation they take a sample case with them in the car. This case is now on display in Herzogenaurach. The first orders arrive quickly. From 1953, all new cars that are built in the young Federal Republic feature Schaeffler bearings ex-works. To this day, innovative bearing technologies from Schaeffler allow carmakers to develop more powerful and more efficient vehicles.

But other industries in postwar Germany prick up their ears. Cage-guided needle roller bearings, to name just one example, have decisively advanced the use of roller bearings in printing machines. The classic concept of the master cylinder non-locating bearing arrangement in the offset printing machine has been based on a Schaeffler solution for 50 years – the double



row roller bearing with offset cage pockets. Once again, one innovation follows on the heels of another.

It soon becomes clear that needle roller bearings with their combination of high dynamic load capacity and low space requirements are extremely interesting for machine tools – a market that Schaeffler systematically captures after its first attendance at the Hannover Messe in 1954. There, the newcomer unveils its drawn cup needle roller bearings. They combine product innovation and production know-how at Schaeffler. The deep drawn process is a forming technique and is still a part of the Schaeffler Group's core technologies today. The drawing is done by large transfer presses using high pressure without the metal sheets being heated in advance. This allows the bearing components to be mass-produced economically and thus provides an impetus for further innovations.

1969 marks another important year in the history of the company. INA linear roller bearings allow the switch from linear sliding to rolling guidance systems for the first time. At that time, this simple component proves to be an innovation for production equipment: heavy-duty, yet smooth running and easy

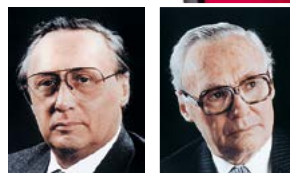

Two great German inventors: the inventor of the needle roller bearing Georg Schaeffler (left) and his brother Wilhelm. With the sample case shown here, in 1950 Georg Schaeffler set off on a tour through Germany



to assemble. In its development, the engineers at Schaeffler rely on knowledge from bygone eras. Even the ancient Egyptians knew that rolling works better than sliding. They used the principle of the linear rolling guide around 2000 BC to move the massive stone blocks to build their pyramids. In the twentieth century, various mechanical linear guiding systems are developed. The INA linear roller bearing finally heralded the breakthrough. Meanwhile, the fifth generation is on the market.

### Applying competence

Again and again over the years, Schaeffler discovers new areas in which to expand its product range. Still, such inventions don't just appear out of nowhere – the steady increase in the company's know-how seems

to be an ideal breeding ground. For Schaeffler as an innovation leader, its partnerships with universities, institutes and research facilities play a major role. The production expertise at Schaeffler also plays an important role in the innovation process. Without precision machining in the micrometer range, for example, the hydraulic valve clearance compensation in the internal combustion engine, which Schaeffler facilitated in the 1960s, would be unthinkable. This in turn led to innovations such as the camshaft phase adjustment or the fully variable hydraulic valve control system, Uni-Air, of which the millionth unit left the assembly line in the USA in spring 2016.

Just like back then, today the sales engineers at Schaeffler are talking to customers to explore opportunities to use production expertise for new developments. Schaeffler often invests in its developments in

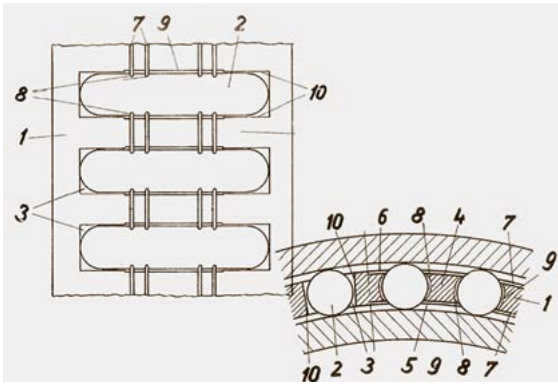

Georg Schaeffler got the idea for his groundbreaking cage needle roller bearings while driving a car in 1949. He presented his invention schematically with these detailed drawings. By 1953, Schaeffler's bearing technology is fitted into every car that is produced in the Federal Republic

**INA**

*Nadellager  
Nadelkäfige*

Die raumsparende Lagerung für hohe Tourenzahlen ab 5 mm Wellenstärke

*Lagerrollen · Zylinderrollen · Gelenkrollen*

**INDUSTRIEWERK SCHAEFFLER**  
FABRIK FÜR NADELLAGER

**HERZOGENAURACH BEI NURNBERG**  
Telefon: 170, 172, 5 · Telegramme: Schaefflerwerk · Telex: 062191



Driver of innovations: The Competence Center Surface Technology, which opened in 2007, has developed exceptionally well. Since then, Schaeffler has increased its sales of coated components by more than 50 percent

advance. When the supplier developed the efficiency-enhancing dual-mass flywheel after the oil crisis in the 1970s, the automobile market was not yet ready for the innovation. “None of the automobile manufacturers wanted it,” recalls the former head of development Wolfgang Reik. “But we were convinced that they would need it eventually.” And so they did: In 2014, Schaeffler delivered the hundred millionth dual mass flywheel.

---

### ***How, what, and with which***

---

Just as important as technical developments is the expertise that Schaeffler has invested in recent years in the area of material. The Competence Center Surface Technology, which went into commission in 2007, has developed exceptionally well. Evidence of this: Since 2007, Schaeffler has increased its sales of coated components by more than 50 percent.

The latest developments from Schaeffler also enable multi-functional and sensory layers, which in turn pave the way for new innovations. With sensory layers, forces, torques and other parameters can be measured

in the bearings – and this with a signal quality that is far superior to conventional sensors. This is particularly useful in, for example, electric cars, electric bicycles and mechanical engineering in general. Combined with smart actuators, sensory coatings prove to be ideal systems to operate engines and machines optimally.

It is entirely possible that one of the more than 2,000 patents that Schaeffler has filed in 2015 will someday be as significant as the solution that Georg Schaeffler found for a sturdy needle bearing.

---



### **THE AUTHOR**

**Johannes Winterhagen** (45) from Frankfurt am Main is a freelance technology and science journalist. He has a special fondness for historic technology – no matter whether it's old steam locomotives, vintage cars or the first Walkman ...



A photograph of a building entrance. On the left, a large, dark green bush with many small white flowers grows over a wall made of large, grey, rounded stones. To the right, a modern glass door with a metal frame is set into a light-colored wall. The scene is lit with warm, golden light, suggesting late afternoon or early morning. The overall mood is serene and architectural.

# FORGING NEW PATHS

Good ideas don't grow on trees, you need people to foster creative processes. For this very reason, Schaeffler has put together an Innovations Management team. What happens there?

— by Wiebke Brauer







The road to the future can be rocky. Those who enter new territory must expect setbacks. But, innovative developments are only possible when contradictions are overcome



— No playground. No baby-blue walls. No excited kids chasing each other around the ping pong table, or, like Dennis the Menace, cooking up the next dastardly plan. Instead, there is a wall with the Schaeffler logo, a screen, a table. And people who know what they're doing. Their names: Dr. Heinrich Schäperkötter, Lars Deppe, Dr. Armin Lau and Verena Pfeuffer. They belong to the 15-strong interdisciplinary department of Innovation Strategy, Innovation Management and Research Funding at Schaeffler and Innovation Projects: Amongst them are a cybernetics expert and a couple of industrial engineers, some members even come from a psychology or engineering background.

Their job is to methodically and carefully sow new ideas and to cultivate the growth as in-house consultants. It's a little like a group of gardeners who nurture and maintain a garden of small and large plants, sometimes even having to prune the odd branch. And this in a world that is becoming increasingly complex and one in which it is no longer enough for a company to simply produce a little more or a little better than before. Quantity is great, quality is better – but ingenuity is what girds an enterprise like Schaeffler for the future. This is why the team led by Dr. Schäperkötter evaluates innovation projects, drives new business fields and asks the right questions. Targeted lateral thinking. This also applies to radical innovations like micromobility.

For more than 15 years now Schaeffler has intensified its capacity for new ideas through idea management. In fact, the first inventions date back to the forties and show that concepts, designs and sketches from that era were converted into real products. As an example, Lars Deppe, Head of Innovation Management, calls attention to the cage-guided needle roller bearing. "Times have changed, but the culture at Schaeffler has always been about thinking

# OUTSIDE THE BOX."

for instance, to begin with ideas, as Lars Deppe explains:

Innovation management cannot be converted into money, you can't touch it, and you can't sell it over the counter. And the road from a brilliant idea to success is long. Nobody today sits at a workbench, gazes out of the window, has a moment of inspiration for a new engine technology and becomes rich overnight. Instead, innovations are born from a deliberately planned process and a clearly defined task. Therefore, it's not efficient, as Lars Deppe explains: "First we have to identify the search fields – from a customers' viewpoint, in terms of trends, from various perspectives of competency." And for this you need not just one person, but many. Deppe adds: "If we want to solve a problem in the automotive sector, someone from that industry joins us. Then the first thing we do is to analyze and compartmentalize the facts."

Schaeffler also invites outsiders, people who are not suspicious of suffering from tunnel vision and can bring a fresh perspective to the table. Futurologists, for instance, who tell us what trends will move us tomorrow. When Schaeffler launched the event 'Open Inspiration,' more than 50 external companies, research institutes and universities came together to present their new developments and research projects.



At least one step ahead of the present day: Dr. Armin Lau, Verena Pfeuffer, Lars Deppe, Dr. Heinrich Schäperkötter and their eleven colleagues from Schaeffler's Innovation Management team



Other tools used to manage innovations are classical creative techniques: These days everyone knows what ‘brainstorming’ entails, but here they use different methods. Dr. Armin Lau explains: “With the

## WALT DISNEY METHOD

you tackle a problem from different perspectives. While Gyro Gearloose sees things from a technical standpoint, Scrooge McDuck is more interested in the bottom line. Donald, however, thinks about what could go wrong.” Verena Pfeuffer, on the other hand, is a specialist in the field of TRIZ, the Russian acronym for ‘Theory of Inventive Problem Solving’ – or put simply, a methodology stating that innovative developments are only possible when contradictions are overcome. “But it’s not about the methods,” says Pfeuffer, “it’s about solving problems – ultimately it doesn’t matter if we use TRIZ, brainstorming or the Synectics creative method.” It becomes even more tangible when the participants in one of the many workshops have to put on a so-called aging suit so that they know how it feels for older people to move. The objective of this exercise is to trigger emotions towards the problem and to give participants a closer understanding of the systems.



» You have to go off the rails mentally. No computer can do this

Dr. Heinrich Schäperkötter,  
Head of Innovation Strategies



“You have to go off the rails mentally,” adds Dr. Heinrich Schäperkötter. “Computers can’t do this.” Especially not in a world that is becoming more complex and is increasingly influenced by individual human needs. Schäperkötter asserts: “Regardless of what lies in the future, it will be characterized by complexities. It is all systematically interdependent – and every solution that helps people cope with these complexities is useful and is a good business idea.” Of course, right now everyone is thinking about the iPhone, an ingenious product that mankind seems to have been waiting for. It looks great, it’s jam-packed with technology, but it’s easy even for simpletons to use – a conglomeration of fulfilled dreams, a device that makes everything a little bit easier. And this is precisely how Innovation Management thinks. This is something quite new. Until now, the world of production has been busy looking at topics purely from a technical perspective – Schaeffler included. Schäperkötter says: “The world is becoming more colorful and diverse. It’s simply not enough





Don't lose orientation even when the path is obscure – that is one of the challenges facing innovation management

to make more. And it's also not enough to make something better. Namely, you also have to make things differently. And that's innovation." But most important is the 'when.' "Nothing is more successful than the right idea at the right time," Schäperkötter continues. "The timing is a huge consideration when making decisions. When is the right time? For this, you need to bring together many separate aspects and make them plausible. Classical marketing prognoses are not enough, it's too simplistic."

Another point which underlines the extent to which time has changed is hegemonic knowledge. Gone is the era in which a few kept their knowledge to themselves for the sake of maintaining power. More successful are those who share their knowledge, circulate it and develop it to the utmost with many others. Knowledge grows through sharing. One minor disadvantage: There are no more heroic stories. No inventor who tears his hair out and devotes his entire life to an idea. No genius who announces the moment of enlightenment and no researcher who is celebrated for his flash of inspiration. Although, one could also say that many of the heroic tales were based on myth rather than fact. In the meantime we know that the invention of the light bulb cannot be credited to Thomas Alva

Edison, but that his design was simply the first to go into production. Still, it's a bit of a shame about the heroic sagas. But that's not what Schaeffler thinks. What one can find is lateral thinking with systems, innovation as a team effort and a corporate culture that carries

## INNOVATION IN ITS DNA. —



### THE AUTHOR

*The Hamburg journalist **Wiebke Brauer** is an avowed iPhone junkie and regards navigation systems in modern vehicles as the best invention in the world – which doesn't stop her from constantly arguing with her Navi because she believes her way is better.*





# THE **OFFICE** FOR **PATENT** SOLUTIONS

The smartest Germans live in Hamburg, according to an IQ test involving 100,000 participants. Really? Because there are a few people in and around Munich that know what our future looks like. Well, not in every respect. But at least a little. That's because the employees of the German Patent and Trademark Office (DPMA) are about six years ahead of us normal citizens. Based on the patent applications filed, they have a glimpse of the future, in a manner of speaking. For instance, DPMA employees knew about the possible uses of nanotechnology years before the first self-cleaning textiles were launched.

## SINCE WHEN HAS PATENT PROTECTION BEEN POSSIBLE IN GERMANY?

*As far back as on May 25, 1877, in the days of Imperial Germany, the first German patent authority, the Imperial Patent Office, was established in Berlin.*

## WHO FILED THE FIRST PATENT APPLICATION?

*Johann Zeitner from the German Ultramarine factory. The patent was granted for a 'Method to Produce an Ultramarine Red Pigment' on July 2, 1877.*

## WHAT IS THE PURPOSE OF PATENTS?

*To protect inventions. Inventors – be they companies or individuals – invest a lot of money and time in the development of innovations. With a patent, a company can use its development itself for 20 years or sell licenses to recover the money invested in the development. If this possibility didn't exist, companies would hardly continue to invest in research and development. The Fraunhofer-Gesellschaft, for instance, holds several patents for H264 data compression that enables the storage and transmission of high-resolution images. A manufacturer of television sets pays royalties amounting to about 30 cents to Fraunhofer for each set sold. With some 200 million TVs sold per year, that's not a bad return.*

## WHAT QUALIFIES FOR PATENT PROTECTION?

*Technical developments and methods, brands/trademarks, and designs. This presupposes that the asset to be protected is new. Technical developments and methods must be suitable for commercial use and go beyond currently available state-of-the-art technology. They can be protected for a maximum of 20 years. While the protection of designs expires after 25 years at the latest, brands and trademarks may enjoy protection for indefinite periods of time.*

## CAN ANYONE FILE A PATENT APPLICATION?

*Yes, applicants may be individuals or organizations. However, the party filing the patent application doesn't necessarily have to be the inventor. This particularly applies to companies in which inventions are made by employees. However, the patents are owned by the respective companies.*

## WHAT RESEARCH DO EXAMINERS PERFORM TO PROVE THAT AN INVENTION IS TRULY NEW?

*For this purpose, the civil servants go through various databases. The in-house DPMA database alone contains over 70 million patent documents. In addition, the examiners have access to patent publications from the United States, Japan, Korea, the European Patent Office (EPA), and the World Intellectual Property Organization (WIPO).*

## HOW LONG DOES IT TAKE FOR A PATENT TO BE ISSUED?

*After filing the application, the inventor has to file a request for examination within seven years. The inventor has to prove that the invention works as described. Patent examiners subsequently need about three more years of research before a patent is issued, depending on the complexity and type of the invention.*

# 2,518

**innovations** were filed by Schaeffler with the Patent Office in 2014. As a result, the technology corporation ranked ahead of Siemens (1,806 patents), Daimler (1,797) and BMW (1,464). The ranking was led by Bosch (4,008). U.S. automakers Ford (1,390) and GM (1,080) were the most prolific foreign patent applicants.

## WHAT DO I NEED FOR FILING A PATENT APPLICATION?

*It suffices for inventors to describe their inventions with all of the key characteristics. But beware that, once it's been filed, the scope of permissible changes that may be made to a patent application is very limited. So, the first filing should be sound. Important advice: inventors who initially take their inventions to a newspaper or magazine, or publish the development stages in a blog, are out of luck. Once an invention has been published, it's no longer deemed to be new and can't be patented.*



A look at the archives of the German Patent Office in Berlin back in 1930 – an endless sea of index cards. Today, computers assist in filing the documents



**15,022** patents were granted in 2014

**625** patent applications were filed by universities in 2014

**116,702** patents in the repository



**85%** of all inventions are made by employees

**7/2/1877** first German patent

# THE PATENT OFFICE

## FACTS AND FIGURES

**3** branch offices (Berlin, Jena, Munich)

**20** years is the term for a German patent

**40 €** is the fee for an application

**365.8 mill €** in earnings

**793,704** registered trademarks

**144 mill €** in HR costs



Over

**800** patent examiners

**305,522** registered designs

As of 2014

## WHAT DOES A PATENT COST?

*The fee for filing a patent application is 40 euros. In addition, costs of 350 euros will be incurred for the examination process. However, a patent application is a complex process and should be supported by an experienced patent attorney, which can easily drive up the costs to 10,000 euros or more. In the United States and Japan, you can expect to pay twice this amount, and filing an application with European Patent Office may well cost 70,000 euros, including research and attorneys' fees.*

## WHEN DOES THE PROTECTION OF AN INVENTION BEGIN?

*Protection by a patent only begins upon its publication in the Patent Gazette. Due to the backlog of pending patent applications, many companies, in addition to the patent, file an application for a so-called utility model (see below).*

## HOW MANY PATENTS ARE FILED PER YEAR?

*In 2014, the DPMA received 65,958 patent applications, 48,144 of them from Germany. Most of the German applications came from Bavaria (15,533), Baden-Wuerttemberg (14,533), and North-Rhine Westphalia (7,116). 6,056 applications were filed from the United States. 15,022 patents were issued and 176,951 examinations are still pending.*

## WHAT IS THE DIFFERENCE BETWEEN A UTILITY MODEL AND A PATENT?

*The protection of a utility model begins when it's entered in the register. A utility model is not subject to examination. The disadvantage: due to the lack of examination by the Patent Office, a utility model is easier to challenge in court by third parties. In 2014, 14,748 applications for utility models were filed with the DPMA.*

## WHAT ARE MOST PATENTS APPLIED FOR?

*Most of the patent applications filed with the DPMA in 2014 were in the field of vehicle engineering. These 6,782 patent applications in 2014 accounted for about 33 percent of all applications filed in this sector around the globe. As a result, Germany is the world market leader in automotive engineering.*

## IS THE PATENT PROTECTION VALID ONLY IN GERMANY?

*The German Patent and Trademark Office can only issue patents for Germany. However, it will assist with applications filed with the European Patent and Trademark Office, as well as with international applications under the PCT that encompasses 148 contracting states. A patent with worldwide validity doesn't exist.*

## HOW DO YOU BECOME A PATENT EXAMINER?

*Applicants have to prove that they've earned a university or college degree, for instance in mechanical engineering, automotive engineering, mining and metallurgy, civil engineering, electrical engineering, physics, chemistry, or medical technology. In addition, applicants must have five years of work experience in their field of study. Applicants also have to be German citizens or citizens of an EU member state to meet the prerequisites of the German Federal Civil Service Act.*

## WHAT HAPPENS IF SOMEONE USES MY INVENTION ANYHOW?

*In that case, you can only take civil action. But beware that any patent may be used for research or private purposes. Only its commercial use is prohibited.*



## THE AUTHOR

**Carsten Paulun (born in 1967)** already had an avid interest in innovation-related topics – even outside the horsepower world – when he was the editor in charge of *Cars & Technology* at 'Bild.' Today, he draws on his technical knowledge as a freelance author writing about anything that moves and moves people – typically involving truly patent solutions.





# GETTING THERE FASTER

Team ABT Schaeffler Audi Sport is one of the key players again in Formula E this year. The design of the electric motor and transmission in the Schaeffler powertrain is one of the factors of success. The experiences from the race track accelerate production developments as well.

— by Lukas Stelmaszyk



— Environmental pollution, global warming, gridlocks and the finite nature of fossil fuels – the challenges posed to the mobility of tomorrow are immense. The electrification of mobility is a central forward-thinking topic of strategic importance which the officials in the world's first racing series with fully electric vehicles have committed to as well. In the competitive environment of the recently incepted electric racing series, the development of electric cars is driven under the aspects of environmental friendliness, economy, and sustainability.

From day one, Schaeffler expressed its interest in entering Formula E and has been supporting ABT Sportsline – the only German outfit in the series so far – since the inaugural season. Thanks to an adjustment of the regulations at the beginning of the season, the teams are now allowed to develop their motors and transmissions themselves, among other things. Therefore, the partners

met for initial discussions in fall of 2014 in order to intensify their collaboration. Half a year later, the first components had been produced for the new ABT Schaeffler FE01. Since the beginning of the season, Schaeffler has been Team ABT Schaeffler Audi Sport's technology partner for the powertrain and official motor supplier.

---

### *Further developments pay off*

---

The ABT Schaeffler MGU 01 electric motor is the centerpiece of the partnership. During the development of the motor, the engineers focused on achieving maximum efficiency, high reliability, optimum thermal management thanks to modified cooling, and higher torque than with the standard-specification McLaren motor all teams had to use in the first season. "We now have a lot more torque so that we were able to reduce the transmission to three speeds," says Lucas di Grassi. The



higher torque has significantly enhanced the car's handling characteristics as well. At the same time, Schaeffler managed to make the powertrain considerably lighter. All of these further developments have already paid off on the race track.

---

### ***"The coolest race car"***

---

Just like di Grassi, his teammate Daniel Abt has been on the Formula E grid since 2014. He still remembers his first race in a Formula E car well. "You expect it to be a lot quieter than a car with an internal combustion

engine. And it is. But, honestly, it's the coolest race car I've ever driven."

The electric racers glide across the city street circuits with a unique whirring sound. Abt and di Grassi agree: "The absence of noise helps," if for no other reason than the fact that it minimizes stress in the cockpit. "You still know what rpm range you're in," says Abt, while di Grassi adds: "You get all the feedback you need as a driver. It starts with squealing tires but also concerns the suspension. That's unthinkable with an internal combustion engine." At 80 decibels, the electric racer is only slightly noisier than a normal passenger car



Centerpiece of the partnership: Schaeffler developed the new powertrain together with Team ABT

If it bears Schaeffler badging, Schaeffler is what you get. The new electric motor is lighter, more reliable, and more efficient



(70 decibels) but clearly quieter than a Formula One race car that generates about 140 decibels.

Schaeffler's objective was to develop an electric motor including power electronics that was as light as possible. To achieve optimum weight balance and a low center of gravity for the vehicle, system integration is another important aspect.

---

***“Torque is immediately available”***

---

Electric motors provide full torque straight from the start. Torque remains constant up to the prescribed maximum output and subsequently drops reciprocally to motor speed. For the developers, there are two parameters to be observed. On the one hand, torque is determined at the start by the starting torque that



# FORMULA E AS A TEST BED

*The drive architecture of tomorrow: Hybrid and electric vehicles will play an increasingly greater role in the mobility of the future. Motor sport is an ideal laboratory for developing drives and technologies. Pressure from the competition accelerates the development process of efficient components. Schaeffler is therefore the exclusive technology partner of the ABT Schaeffler Audi Sport Team in the world's first series for all-electric formula racing cars.*

## ELECTRIC MOTOR

*The heart of the new drive-train is the electric motor developed by Schaeffler. It has higher torque and improved efficiency than its predecessor.*



## SOFTWARE

*The electronic control unit and its newly-developed software ensure all components work in perfect harmony and with the highest efficiency.*

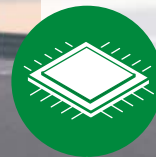

## TRANSMISSION

*The 3-speed transmission, which is perfectly matched to the new motor, ensures efficient gearshifts due to its electric actuator. It is more rigid and more compact than the previous version.*



## BATTERY

*The car's energy source with a capacity of 28 kWh provides a reliable supply of electricity to the motor.*



can be transferred to the tires. On the other hand, the motor has to achieve a defined maximum speed. Therefore, these are the two central design factors. "I was surprised to see how fast the car accelerates," says di Grassi: "From zero to 100 kilometers in about 2.9 seconds. Torque is immediately available and easy to control as well: full speed ahead with a tremendous amount of fun."

ABT and Schaeffler also jointly developed a new transmission adapted to the ABT Schaeffler MGU 01 that was produced by Hewland according to special specifications. Compared with the first-season transmission, the evolution is stiffer and more compact.

With respect to gearing, the Schaeffler engineers had to settle for a compromise. Principally,

## EFFICIENT THANKS TO SCHAEFFLER KNOW-HOW

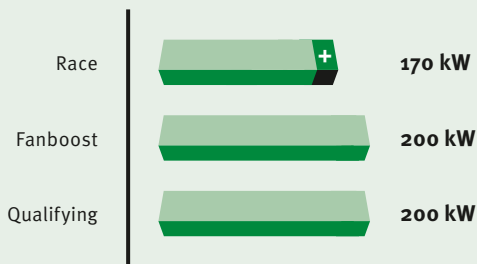

*In contrast to the inaugural season, the drivers are now allowed to fully use a maximum output of 170 kW. That's 20 kW more output while the specified battery power has remained the same. This is made possible by the enhanced efficiency of the powertrain of the motor and transmission developed by Schaeffler, plus the optimally adapted software suite.*

» **Formula E has picked up the topic of electric mobility in an ideal manner. There, we can perfectly explore the potential for the mobility of tomorrow**

Prof. Peter Gutzmer,  
Chief Technology Officer

range allows for a lighter design of the motor. Weighing advantages against disadvantages implies the need of accepting trade-offs that applies to racing as well as to production technology.

Unlike in Formula 1 or the DTM, variation of the gear ratios from track to track is not allowed in Formula E. Consequently, a solution had to be found that allows for fast lap times on all race tracks. Therefore, longer gearing is recommended for top speed, as well as for high efficiency when the motor operates in high rpm ranges. That's why Team ABT Schaeffler Audi Sport opted for a three-speed variant in the 2015/16 season.

Based on the experiences gained in recent months, Team ABT Schaeffler Audi Sport is already in the process of preparing for the 2016/2017 Formula E season. Resting on the laurels of current successes is no option as the competitive pressure in Formula E keeps increasing.

**2.9 SECONDS**  
FROM 0 TO 100 KM/H

transmissions for electric powertrains raise the question of how many gears are needed. On the one hand, a minimization of shifting events is desirable as this reduces shifting delays to a minimum. This is reflected in better lap times but requires a relatively high-torque and thus heavy motor. In order to be able to use a more compact electric motor, several gears are the preferred choice. Designing the unit to always shift in the optimum output





» I make progress by having people around me who are smarter than I am and listening to them Henry J. Kaiser





# outlook

Technology for tomorrow

## ZERO-G PRINTED MATTER

— The basic principle of printing hasn't changed in centuries. In the year 868, China produced the first book using the woodblock printing technique. In the mid-15th century, the Goldsmith Johannes Gutenberg introduced letterpress printing with movable metal letters. Eventually this led to intaglio, relief and later digital printing. But paint was always applied on a two-dimensional surface. Then came 3D printing, one of the most important industrial inventions of modern times, which no longer reproduces images and words but can create objects. The range of three-dimensional printed products is growing rapidly, from toys to machine components to roadworthy cars. 3D printing could revolutionize the logistics industry: Why transport products back and forth across countries and continents when you can print them locally? This would also have major advantages in outer space where the spare part supply is naturally always somewhat critical. So it came as no surprise that the industry responded positively to NASA's news that the U.S. National Aeronautics and Space Administration had successfully demonstrated 3D printing in Zero-G conditions.





# THE SOUND OF **MUSIC**

It doesn't always have to be heavy metal: Lightweight rocks – as long as the composition of lightweight material, design and manufacturing in the car is right. It's not just about staying in tune with weight reduction, it's also about the rhythm in the ballet of the assembly line robots – and about the designers who have to get materials with markedly different properties playing the same tune.



The BMW i8 seems to fly through the assembly hall. The weight-bearing elements in this hybrid sports car are made of carbon fiber and aluminum. The weight that is saved creates room for heavy batteries

— It may well be that Drum 'n' Bass is electronic dance music, but the accelerated breakbeats were not invented in the early nineties. Special techno rock has been playing loud and clear in automobile factories for ages: with the staccato beat of the punching press and riveting machines setting the allegro tempo. And the unmistakable boom of the towering presses rumbles in seismic-sounding ground bass, while hissing rivet robots spit sparks. This sound

inferno is backed by a choir of countless hydraulic and electric actuators, all humming, whining and whistling different notes.

For established coachbuilders, this thundering noise is music to the ears. It's only when everything goes quiet that they feel vexed. And they have to get used to the sound patterns in the manufacturing of new materials:



## LIGHTWEIGHT COMPOSITION OF THE AUDI TT

- Ultra high strength steels (hot-stamped)
- Conventional steels
- Aluminum profile
- Aluminum sheet metal
- Cast aluminum

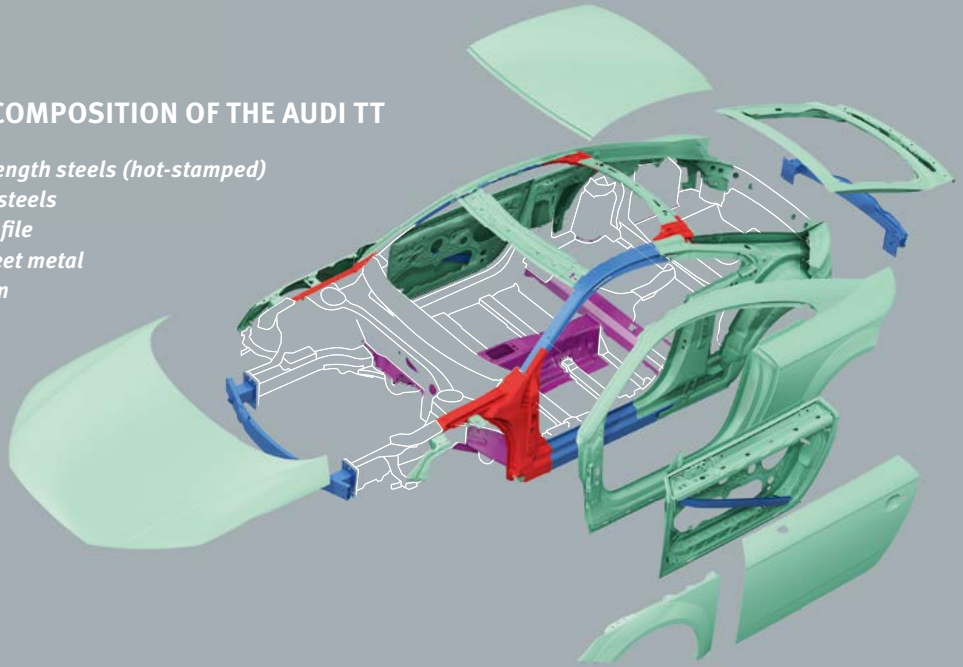

The high-temperature welding of conventional sheet metal is being increasingly supplemented by new techniques as gluing, cold and hot riveting, collar joining or even textile weaving with fiber materials. Adhesives or resins don't just bind the materials, but also keep them at a safe distance apart to prevent electrochemical reactions. Because

even the tiniest fragments of steel can lead to corrosion of aluminum parts, Ford, for instance, had to completely rebuild the manufacturing facilities for its new F 150 within ten weeks. With an annual demand of 350,000 tons, Ford is becoming the largest purchaser of aluminum sheets in the entire automotive industry. The aluminum bodies

# 250 kg

of aluminum on average could be incorporated into every **new car** by 2025. In the year 2000 that figure was between 100 and 120 kilograms.

Source: world-aluminium.org

# €140 BILLION

will be spent on **lightweight construction** in 2020. The average annual growth is 7–8%. The focus, however, remains on lightweight metal. The main driving force is the transport sector with car construction at the top.

Source: VDI Zentrum Ressourceneffizienz

## MATERIAL EXPERTISE

### STEEL

**PROPERTIES** The main constituent in this metallic alloy is iron. More than 2,500 varieties are available, differentiated by strength, corrosion behavior, malleability and weldability

**CONSISTENCY** From pliant (e.g. cans) to ultra high tensile (e.g. submarine steel)

**WORLD PRODUCTION 2014** 1.662 billion tons

**FIELDS OF APPLICATION** Almost all industry sectors

**SUSTAINABILITY** The most recycled industry material worldwide. Recycling quota of 70%. No loss of quality due to recycling. 50% less CO<sub>2</sub> emissions through recycling compared to primary production



and the ladder-type chassis of high-tensile steel make the top-selling model in America up to 320 kilograms lighter. The first-rate lightweight solution also contributes to quenching the thirst of the 5.30-meter flatbed truck by around 30 percent. “With a view to the stricter CO<sub>2</sub> limits, vehicle manufacturers are stepping up their lightweight efforts,” says Christian Weller, Managing Director of the General Association of the Aluminum Industry (GDA).

‘Big is beautiful’ – sports utility vehicles and full-size pick-ups have been popular amongst American customers for decades. The Europeans, too, are treating themselves to noticeably larger footprints on the road. The number of SUVs is on the rise. By 2020, the SUV market share may pull level with the classic notchback saloon. This, of course, is good news for manufacturers of models with an off-road look. But on the flipside, the large, sometimes all-terrain vehicles burden the balance sheet of manufacturers when it comes to weight and CO<sub>2</sub> emissions. Development costs are correspondingly high so that the increased size is not associated with increased weight.

No matter whether new production facilities, procedures or vehicle architectures are needed: lightweight solutions are not as easy as they might at first seem. It’s not just about weight and material costs, it also concerns the crash characteristics and, not least, the production

processes. Depending on the numbers, vehicle size and cost pressure, the diet regime therefore looks notably different from model to model. A conventional mix of 50 percent high-tensile steel, for example, is suitable for compact and mid-size vehicles, which, according to the business consultants McKinsey, a cost of around three euro per kilogram of weight reduction would be worthwhile. And this is not necessarily a bad thing. A B-pillar made from special high-strength steel, for instance, may be lighter than aluminum parts with the same range of functions. The fuel tank with lightweight steel is a winner: it has the best crash absorption capabilities in tandem with low-cost manufacturing processes. In the large car class, says McKinsey, hybrid metal-plastic combinations with high aluminum or magnesium content and a small amount of carbon or glass fiber reinforced plastic are on the upswing. Here as well, additional costs of 5 to 14 euros per kilogram of shedded weight are acceptable. Aluminum pioneer Audi saved up to 325 kilograms of weight in its new Q7 compared to its predecessor by using an intelligent material mix of aluminum, fiber composites and a range of different steels.

### **Carbon fiber: light but costly**

The flyweight amongst the light construction materials is carbon fiber (CFRP). Used cleverly, this

#### **ALUMINUM**

*Only a third of the weight of steel, but the energy required for production is eleven times higher. Hence, aluminum is also known as ‘condensed electricity’*

*Only alloying makes soft aluminum hard*

*53.1 million tons*

*Vehicles, construction, packaging*

*Durable material (stainless). 3/4 of the aluminum ever produced is still in circulation. 100% recyclable. Energy consumption for recycling only 5% of the primary production*



#### **MAGNESIUM**

*Lighter still than aluminum. New extraction (desalination) and manufacturing methods make the material increasingly popular and cheaper*

*Strong, tends to corrode. Easy to process (e.g. cast, sheet metal)*

*775,000 tons*

*Vehicles/transportation, construction, robotics*

*Similarly high energy expenditure in primary production as aluminum. Difficult to recycle as it is rarely pure. Marked loss of quality*



#### **CARBON FIBER**

*Industrially made. 95% used in conjunction with plastic resins, rarely with metal or ceramics. Expensive to produce and process. Noncorrosive*

*Extremely light, stronger than most metals*

*53,000 tons*

*Vehicles, wind turbines*

*Recyclability has shortcomings (around 30% of the annual world production ends up on the scrap heap). Industry aims for a recycling quota of 85%*





material can be about a third lighter than aluminum designs. Moreover, carbon fiber is significantly stronger: Several layers of fiber matting can be oriented so that they are particularly stable in the main direction of the acting forces. For this reason, last year BMW began large-scale production for the first time with CFRP: The new 7-series BMW saves 70 kilos of weight in the highly-stressed areas of the body. Another 50 kilos could be avoided by increasing the use of aluminum. The full advantages of carbon fiber, however, are only played out when the vehicle receives a completely new body design. The B-pillars of the BMW 7-series are made of ultra high tensile, hot-stamped and press-hardened steel, with CFRP included like a sandwich. Thanks to carbon, the roof posts, the side sills and the transmission tunnel are torsionally rigid and crash-proof. However, entire bodies of CFRP, which BMW has developed for its E-Mobile i3 and i8 for example, are an exception: The fiber material from the aerospace industry is still too expensive for large-scale production (currently costing 600 percent more than steel). Through increased use, however, the prices could drop by up to 70 percent in coming years.

Amongst lightweight experts, carbon fibers are definitely at the top of the list: When the Association of German Engineers (VDI) was asked which material would have the highest percentage growth in the auto industry in the coming years, fiber composites held a clear lead with 67.4 percent, far outstripping magnesium (19.1 percent) and aluminum (13.5 percent). This impressive growth, however, should not obscure the high 'springboard' of established lightweight metals. With the relatively new CFRP materials in the automotive industry in particular, costs have to be reduced in the still highly-complex process of manufacturing

## LIGHTWEIGHT DESIGN AT SCHAEFFLER

*Lightweight design is not something new at Schaeffler. For more than a decade now, the supplier has addressed this topic. As far back as 2003, the corporate group INA introduced a versatile machined **needle roller bearing with plastic cage**. This step not only reduced the weight (thus the unsprung mass) but also the dimensions and noise levels. The components proved so sturdy that they can also be used in heavy duty sectors such as commercial vehicles. Another 'light' milestone at Schaeffler is the **INA lightweight differential**: Less weight and compact dimensions (-70% in width) opens up new possibilities for developers – particularly in hybrid powertrains. The world's first **electromechanical roll stabilizer** from Schaeffler also gets a slenderized sibling. The carbon version is a third lighter and hence ideal for sports and race cars. For wind turbines, Schaeffler offers **compact cylindrical roller bearings**, which allow for space-saving designs.*

Bevel differential

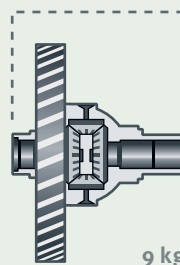

9 kg

Lightweight differential

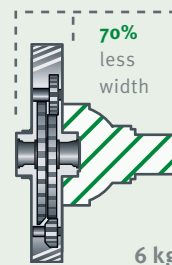

70%

less  
width

6 kg

30% lighter, 70% smaller – the Schaeffler lightweight differential scores points on both counts



» **The rule of thumb in the automotive branch: 100 kilograms less weight in a midsize car equates to 5 percent more acceleration, 5 percent less braking distance and about 0.2 to 0.3 liters per 100 kilometers less consumption in gasoline engines and a reduction of CO<sub>2</sub> emissions by 7 grams per kilometer. If every vehicle in Germany lost 100 kilograms in one swoop, fuel costs would be slashed by 3.25 billion euro with 4.3 million tons of CO<sub>2</sub> emissions saved**

Dr. Wolfgang Seeliger,  
Managing Director of the State Agency for Lightweight  
Construction/Design in Baden-Württemberg, Germany

# PIONEERING AVIATION

*The direction in which lightweight design is heading is evident in the aviation industry. The costs involved in building aircraft is not the most critical factor – equally as important is the increasing payload and the decreasing fuel consumption. For this reason, aluminum, titanium and fiber reinforced plastics (FRP) are at the top of the list of materials used. By 2020, a market growth of around 15% for FRP is forecast in the aerospace industry. The share of magnesium is expected to grow by as much as 30%. The wide-body aircrafts from Airbus (A380) and Boeing (787 ‘Dreamliner’) are already using significant amounts of FRP in their aircraft structures. Future projects such as the Airbus A350XWB will consist of more than 50% FRP.*



Around a third of the annual production of carbon ends up in the aerospace industry. Even the wings of the Airbus A350 are made of the lightweight material (above). But the honeycomb structures of metal also help to save weight – and not just in aircraft design

and further processing. Research priorities in Germany, according to VDI, are therefore to develop cheaper, scalable, automated production techniques. By 2021, experts predict a doubling of worldwide CFRP demand from the current 58,300 tons to around 116,000 tons.

## Help from nature

The issue of weight also plays a major role in the car's interior – this is especially relevant for electric cars with their heavy battery packs. With natural fibers, the specific density is lower than many other materials and, depending on the module, can contribute to a weight saving of 20 to 40 percent. In addition, every kilogram of plant material during the growth phase can absorb approximately 1.4 to 1.6 kilograms of CO<sub>2</sub> and lead to a further CO<sub>2</sub> credit in the overall environmental footprint.

Mid-term, VDI also sees great promise in bionic lightweight design. Research in this field focuses on how structure and design principles of nature can be used for lightweight applications. Lightweight structures in the manufacturing of cars using bionics promises weight savings of up to 50 percent. However, not only must the

right material be used, but in the right quantity and in the right place. What is needed is completely new vehicle architecture to maximize the weight advantage. According to the VDI Center for Resource Efficiency, without new design and production techniques, the shedding of weight is becoming increasingly difficult: Right now it would seem that ‘conventional’ methods of lightweight material, molding and manufacturing in the automotive branch will reach their limit in the 2020s. So the famous techno beat from car factories is not going to stop any time soon.



## THE AUTHOR

*Technological change is everyday business: Dr. Joachim Becker (born 1963) is the technology editor of the ‘Süddeutsche Zeitung.’ The car as a networked robot intrigues the humanities scholar just as much as car drivers who still run the system software 101.*



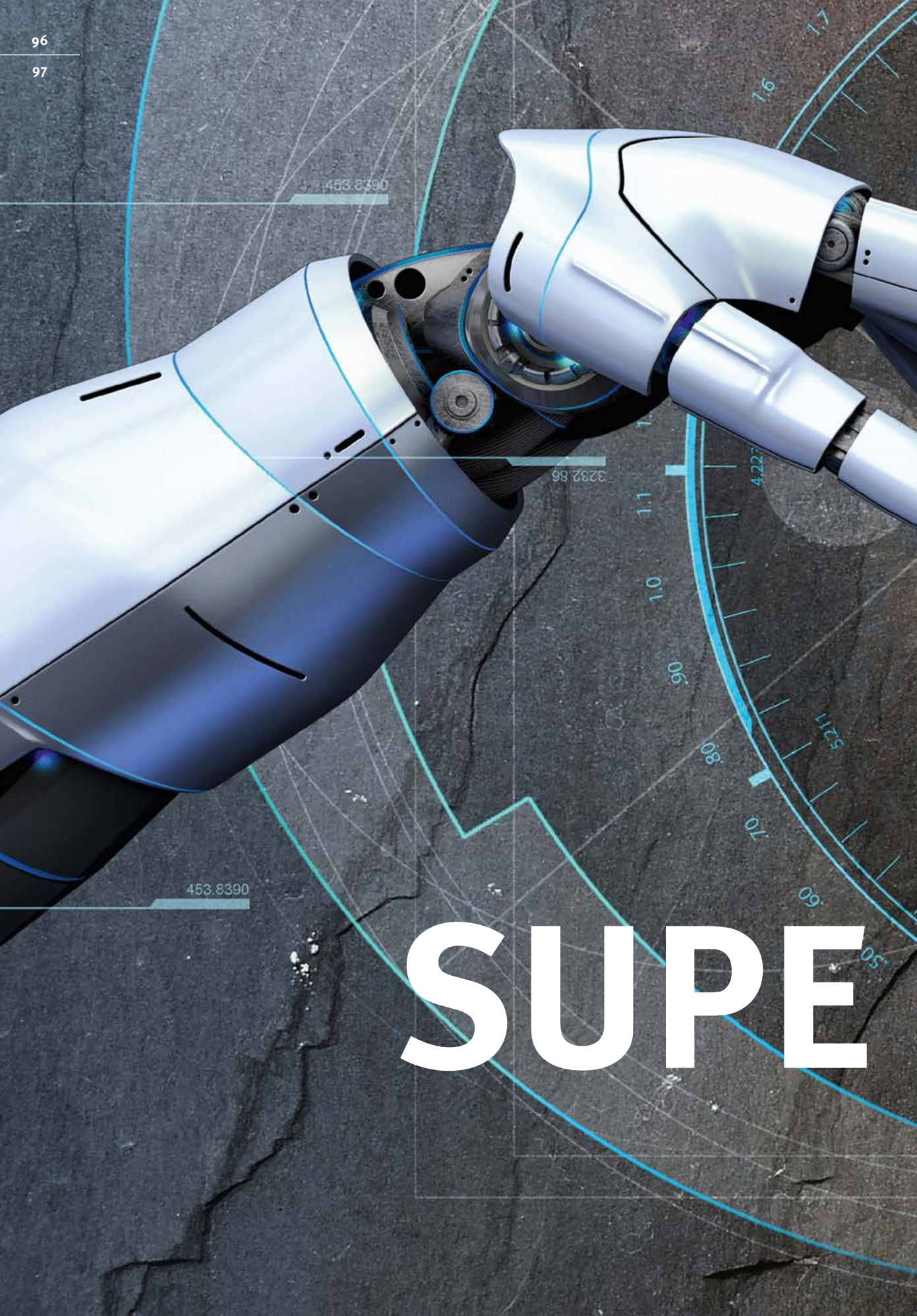

453.8390

3232.86

453.8390

# SUPE



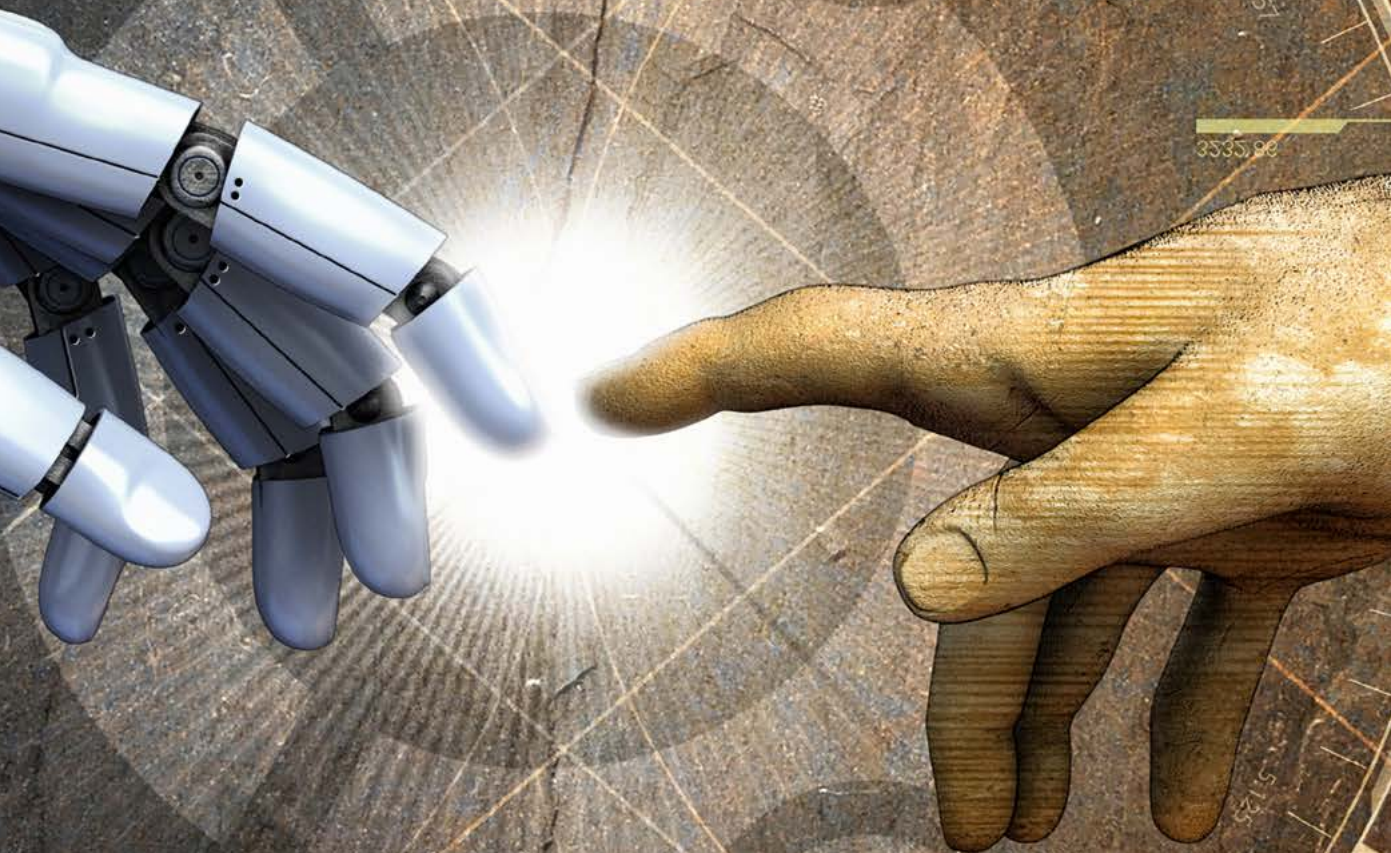

# ON THE WAY TO THE RHUMAN

Research in the field of 'spare parts' for humans is taking place everywhere in the world. When piecing the worldwide findings together, it's clear that we're not far from perfecting our bodies. A status report on Humans 2.0.

— by Thomas Arndt



— A woman, a man, soft music, a fine red wine, and lots of love – that’s the romantic idea of creating a human being. But this human, as we all know, is prone to fail, ail and tire, and to suffer from various weaknesses. Brilliant minds around the globe are involved in research aimed at perfecting their own species by means of high-tech limbs and neuronal controls. While the idea may not be particularly romantic, innovative technology for the human update is no doubt fascinating.

---

### *An endless race*

---

Take American bioengineer Robert Gregg, for example, who has developed a powered prosthesis for the leg together with his team at the University of Texas at Dallas. Thanks to its robot control, this ‘intelligent’ artificial leg is reported to provide disabled persons with the same agility and quality of gait as able-bodied persons. The robotic leg proved its viability in treadmill tests with amputees. “We did not tell the prosthesis that the

treadmill speed was increasing. The prosthesis responded naturally just as the biological leg would,” Gregg says. At speeds of one meter per second, the participants were able to move nearly as fast as fully able-bodied people – without showing signs of fatigue ...

Regarded as the best prosthesis to have been developed to date is the Luke Arm (pictured below), dubbed after the artificial hand of ‘Star Wars’ hero Luke Skywalker. DARPA, the research arm of the U.S. military, is investing a total of 100 million U.S. dollars in the development of artificial limbs that are connected with the human body and controlled that way. The artificial grippers respond so sensitively that test subjects, even at the current stage, are able to pick up raw eggs using the Luke Arm. Naturally, its grip can be forceful as well if it receives the requisite commands.

As early as in 2012, researchers at the University of Pittsburgh managed to connect the brain of patient Jan Scheuermann with a robot arm. The quadriplegic woman

The Luke Arm named after ‘Star Wars’ hero Luke Skywalker, is regarded as the best prosthesis to date. The artificial grippers respond so sensitively that test subjects are able to pick up very fragile items

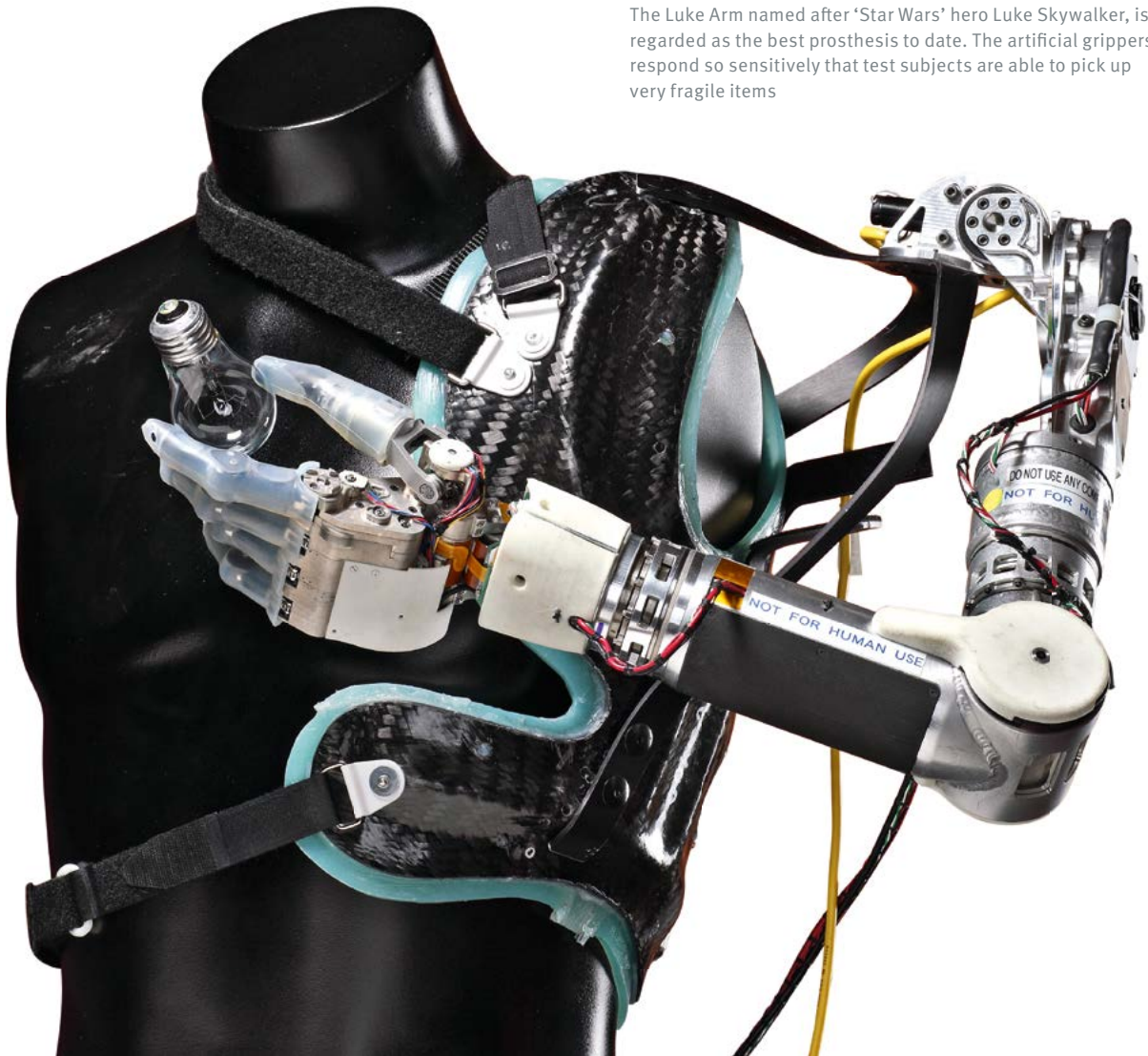

As strong as Obelix: Assisted by an exoskeleton, this Daewoo dock worker easily carries construction parts weighing 40 kilos. 100 kilos are said to be possible soon

## » Our aim is to create an Iron Man suit

Max Scheder-Bieschin,  
Ekso Bionics executive



had electrodes implanted in her brain that made it possible for her to control external devices with her thoughts. As a result, the robot arm was able to bring a chocolate bar to her mouth at an early stage of the project. In 2015, the woman in her mid-fifties even managed to fly an F-35 fighter jet in a simulator – also strictly controlled by her thoughts. This impressive demonstration marks the next step of creating a declaration of independence for the human brain vis-à-vis the body it belongs to.

The Icelandic prosthetics company Össur made headlines in 2015 on being the first to achieve the feat of enabling two leg amputees to walk with thought-controlled prostheses. A sensor the size of a match implanted in the residual muscle tissue of the amputated upper leg transforms the brain's impulses that are transmitted by nerves and forwards them to the high-tech prosthesis. "Mind-controlled prostheses are the next step in bionics," says Össur's CEO Jon Sigurdsson.

### ***Iron Man-style exoskeletons***

So-called exoskeletons are another piece of the puzzle on the road toward the new superhuman. This full-body support is set in motion using physical force. Scientists at the Japanese Hiroshima Institute have developed such an artificial skeleton and named it Unplugged Powered Suit (UPS). It uses the wearer's body weight to produce energy. The pressure from a pump installed underneath the sole dispenses gel to the supporting system with each step the wearer takes. This so-called Pneumatic Gel Muscle (PGM) works like a

natural muscle by means of contraction and relaxation. Various forms of assistance are possible, depending on where exactly the pump and PGM are installed in the exoskeleton. "The UPS is designed to support human motion," says professor Yuichi Kurita. "We can customize the UPS to the user's particular needs such as muscle strength for athletes and rehabilitation."

According to the current state of the technology, the UPS works up to the level of jogging speed, without the need to carry complex technology. Muscle power is strictly used for motion. As a result, a morning run can be clearly longer by exerting the same energy: another small step on the road toward the real-world superhuman.

The same applies to the pioneering HULC (Human Universal Load Carrier) suit by the U.S. arms company Lockheed Martin. With help from HULC, soldiers, as well as civilian workers, can easily lug 90 kilograms of equipment, even at a short-term speed of up to 16 km/h. However, the price for such high performances is currently still in the six-digit range.

Using a similar principle, the Robo suit by the world's second-largest shipbuilder, Daewoo Shipbuilding & Marine Engineering in Korea, turns a normal person into a supercolleague. With incredible ease, the workers at the Okpo-dong docks carry components weighing up to 40 kilos back and forth at the construction site all day long without tiring. Carmaker Honda has already tested proprietary developments of exoskeletons on employees in its vehicle manufacturing



## THE HUMAN-MACHINES

*“Hello, how can I help you?”* Guests checking in at the Henn-na hotel in Japan are not welcomed by a human employee but by robots. Japan is a pioneer in the field of humanoid robots. The human-machines are already being used as bank tellers as well, and nursing services intend to follow suit. Airbus, together with Joint Robotics Laboratory (JRL), is in the process of developing humanoid workers too. At this juncture, these helpers are not only moving around like their flesh-and-blood role models but can even interpret emotions of their human counterparts.

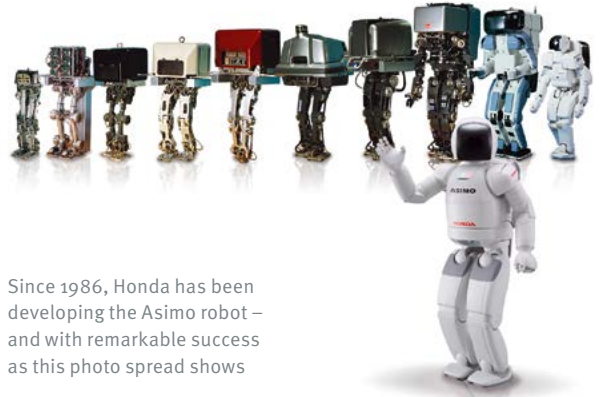

Since 1986, Honda has been developing the Asimo robot – and with remarkable success as this photo spread shows

operations as well. The fact that the tests were preceded by 14 years of development shows the complexity of the matter. The motion assistants powered by electric motors were simultaneously deployed to the rehabilitation centers at hospitals where they accelerated the gait of their wearers that normally tends to be slow to an impressive 4.5 km/h – for a full two hours at a stretch.

Much about the exoskeletons is reminiscent of the high-tech armor worn by the comics and movie superhero Iron Man. Max Scheder-Bieschin, CFO of Ekso Bionics, a company specializing in such suits, doesn't

deny the fact that his developers use superheroes for orientation: “Our aim is to create an Iron Man suit.” And this suit was even able to fly – an age-old dream of mankind.

---

### ***Breathing under water – another step toward Humans 2.0***

---

Danish scientists, on the other hand, have come up with an idea of how to make life possible under water for Humans 2.0 – without complex equipment and bulky compressed air tanks. The Scandinavian inventors have

## MEDICAL TECHNOLOGY BY SCHAEFFLER



The FAG SIMTUS system developed for use in computer tomography accelerates panoramic X-ray procedures and enhances image quality

***Schaeffler successfully operates in more than 60 industrial sectors – including decades of activities in medical technology.***

*With its INA, FAG, Barden and IDAM brands, Schaeffler defines itself not only as a reliable supplier in this as well as its other markets but, thanks to its know-how, also as a development partner. Drawing on extensive experience in diverse fields of application, Schaeffler's experts manage to look at given tasks from new perspectives time and again. This often results in unconventional and amazingly*

*simple solutions, like the thin section bearing that was originally developed for helicopters but now also guarantees 100 percent functional reliability combined with maximum running accuracy and minimal noise development in computer tomography.*

*Material and surface finishing up to plasma or ion-ray coating plays a major part in medical technology. For instance, rotational speeds of up to 500,000 rpm for dental drills or temperatures of 500 degrees centigrade for X-ray bearing units are possible.*

Six Million Dollar Man my foot: An exoskeleton from Ekso Bionics like this one costs 'only' 100,000 U.S. dollars.

The company has already sold more than 100 of them – and the market is growing fast, not least because pared-down versions from other companies selling for less than half open up new customer groups

developed a crystalline material which – like artificial gills – can highly effectively filter oxygen from its surroundings and emit it again in a controlled manner.

So, is the superhuman just a question of time? Even if this makes the hair of humanists stand on end, the answer, arguably, is yes, although Arati Prabhakar, Director of DARPA, the U.S. Defense Advanced Research Projects Agency, is not the only one who is conscious of the fact that modification of physical abilities also raises ethical questions: “We can all imagine amazing good things and amazing potentially bad things.”



## THE AUTHOR

Hamburg journalist **Thomas Arndt** (56) started his career in 1980 as an intern with a daily paper in Kassel. He worked for various publications and agencies before beginning to freelance as a journalist and author in 2014. The technologies and potential of exoskeletons fascinate him – despite a considerable amount of skepticism regarding their utilization outside the medical sector, as he says himself. In his opinion, the real human will remain the better one ...





# URBAN MOVES

All over the world, people are moving to the cities. As a consequence, the volume of traffic in urban areas is also growing. Before everything grinds to a halt, solutions are being sought – at Schaeffler, as well.

— by Jakub Fukacz





— In 1886, arguably the world's most famous engineer in the automobile industry files a patent for a vehicle with a 'gas-powered engine.' "A replacement for horses!" With this statement, Carl Benz advertises his Patent Motorwagen, which, from today's perspective, represents the decisive innovation for an entire industry. His contemporaries back in 1886, however, are rather indifferent towards him. After all, there is no demand for automobiles, so this invention seems bound to fail. Today, 130 years later, around 19 million vehicles are registered every year in China alone. Worldwide, the existing fleet of vehicles is estimated at a mindboggling 900 million.

At the same time, climate scientists and politicians are struggling to implement new environmental protection plans and to limit the steady heating up of the planet. Urban and transport planners are sounding the alarm. Seven billion people currently call this blue planet home. According to UN estimates, by the end of the decade this figure will mushroom to more than eleven billion: a rapid development which also goes hand-in-hand

with the inevitable changes in mobility needs. But how might this new world look? Fundamentally, the global demand for mobility will rise. Despite increasing globalization, it will not, however, be a 'one size fits all' solution when it comes to mobility. Different countries, different options, different desires, different needs.

Whether Istanbul, Tokyo or Shanghai, the megacities of our world are bursting at the seams. Every day, they are plagued by gridlocks. In New York's district of Manhattan, for example, the high density of traffic leads to permanently crowded streets, high noise levels and the desire for faster and cleaner ways to travel. The Big Apple is responding and paving the way with sustainability initiatives – for example, by 2020 one third of all taxis in Manhattan will be electrically powered.

Right now in China, 16 million cars travel on the streets of the megacities. By 2050, this number is expected to quadruple. With Chinese cities already murky with smog, it is obvious that 'business as usual' is not a consideration.



A cross between an e-bike and a subcompact electric car: Schaeffler advocates a bio-hybrid vehicle for micromobility



The Chinese government has recognized this as well and is now focusing on resource-conserving and fuel-saving concepts. Part and parcel of this is the promotion of so-called New Energy Vehicles (NEV). In electric mode, they must achieve a minimum speed of 100 km/h and an electric driving range of at least 50 kilometers – and it's no coincidence that plug-in hybrids can achieve these parameters.

More than a third of the global inner-city traffic is made up by motorists looking for a parking spot. The average speed in Indian cities is 15 km/h, in Mexico City it's 6 km/h. True to the motto: Those who walk, walk, those who drive, wait. This very likely also applies to the 37 million people living in Tokyo. Here too, the automobile as the main mode of transport has reached its limit, hence other mobility solutions are needed. But which needs are to be met in the future? The challenges are manifold.

### ***Eco-friendly drive systems: innovative mobility solutions***

In this wide field – ranging from the automobile sector to other urban and interurban mobility forms such as two-wheelers, rail and air transport, to forms of energy generation such as wind, solar and hydro power – Schaeffler embraces every bit of it for mobility in the future. Always in focus: megatrends such as globalization, urbanization, digitalization, changing values and the growing need for affordable mobility, leading to much more dynamic market requirements and new business models.

Mobility is not just a basic human need, it is also closely correlated to economic growth. This applies not only to the transportation of people but also of goods. Current trend studies show that especially in the cities the demand for a flexible, ecological and cost-efficient alternative to the traditional family car is growing. And the shift began long ago.

Eco matters are currently en vogue with urban planners. The unofficial title of 'bicycle capital of the world' is as coveted amongst mayors as an Olympic gold medal is for athletes. Right now, Copenhagen and

With e-taxis, the expansion of bicycle and pedestrian paths, as well as public transport and the networking of all transport systems, Manhattan aims to get fit for future mobility



Amsterdam are dueling for the honor of being the most bicycle-friendly city. Copenhagen has the most traveled bike paths in the world. Up to 30,000 people pedal over the Queen Louise Bridge every day. In fact, they have even introduced the word 'Copenhagenize' as a synonym for 'becoming cycle friendly.' 1:0 for Copenhagen. But Holland's capital city easily counters this. 73 percent of the population own at least one bicycle, 58 percent cycle every day and ride two million kilometers – per day, not per year. Draw Amsterdam 1:1. But wider cycle paths, bike parking garages, gas stations with bike pumps, slanted trash cans, bicycle control systems and modern motorways for bikes away from traffic are just the beginning. Innovations such as the Pedelecs, which are electric bikes, are gradually turning cycling into a problem-solving and health-promoting lifestyle.

Other cities and regions such as Vienna, London, Hamburg and the Ruhr region are also striving

## 15%

quota for bicycles is what **Paris** is aiming for. For 150 million euro, the network of cycle paths should double to 1,400 km. The goal: by 2020, Paris wants to be the bicycle capital of the world.

## 0.5%

of **Istanbul** traffic is tackled by bike – negative world record.





for innovative mobility solutions. Since the summer of 2013, for example, two bus lines in the city center of the Austrian capital are powered solely by electricity. By 2023, London plans to invest over a billion euro into so-called Cycle Superhighways. For under the earth, there are plans to upgrade subway tunnels with long moving sidewalks to provide pedestrians with weatherproof highways. The prestigious project in the Ruhr region in North West Germany is the 100 kilometer long *Radschnellweg* (Fast Bike Path) RS 1 running from Duisburg through the Ruhr region to Hamm. The *Radschnellweg* is four meters wide and links ten cities and four universities. For pedestrians there is even a separate sidewalk next to the bike path.

The extension of the bicycle infrastructure is trending right now. In the meantime, more than 2.1 million Pedelects are out and about on Germany's streets alone. According to a study, sales should triple by 2023. As stated in the magazine 'Trekkingbike,' the number of bikes sold worldwide with and without electric drive in 2012 was 132 million – and steadily rising.

---

### ***Electric cars, car-sharing and vehicle hopping***

---

When it comes to innovative car traffic systems, Norway is the clear leader. Per capita, nowhere are more



This illustration from the company on3studio for the Urban and Transport Planning Agency ARGUS shows how Hamburg's main thoroughfare 'An der Alster' might look in the year 2050. Clearly noticeable on the image: micromobility dominates the traffic





electric cars to be found. Benefits such as free parking in designated areas, tax exemptions and the right to use bus lanes are only a small extract from the Norwegian catalog of advantages. The fact that things are also done differently is apparent in Mumbai. There, the government has other priorities. Mobility objective number one: “to enforce the observance of traffic rules and improve security.” There it is again – different countries, different customs.

There are several different ways to look at electromobility: In most cases it is associated with the electrification of the powertrain. Well known vehicles in this product range include the Renault Twizy, Smart, Opel Ampera, BMW i3 or the VW e-up, in addition to the numerous

hybrid models. The efforts of the manufacturers receive support from innovative suppliers. Schaeffler’s portfolio in this segment ranges from hybrid modules via the electric axle through to wheel-hub drive, which allows unprecedented packaging concepts in vehicle development. Schaeffler products can be fully integrated into hybrid vehicles and all-electric cars.

The second school of thought does not alter the car, but how it’s used. On average, the privately-used car stands stationary for 23 hours a day, often blocking public parking spaces. In many cities, car-sharing initiatives such as Car2go or DriveNow have already been established. However, the vehicle fleets used by the providers





are predominantly powered by combustion engines. High initial outlay, patchy charging infrastructure and an unfamiliar operation of electric cars are three of the most important obstacles that need to be overcome. Irrespective of this, a rosy future lies in car-sharing as part of a mobility mix, especially in combination with the bicycle and public transport.

---

### ***Future-oriented mobility: search box micromobility***

---

Another trend is heading towards new, compact mobility solutions and makes way for small vehicles that can close the gap between the electric car and the

bicycle. We are talking about micromobility. For Schaeffler, this is one of the main innovations on the road to future mobility. The technology enterprise is currently exploring a stand-alone vehicle platform in this segment. Factors such as future needs, areas of application, concepts and solutions play a part. The depicted bio-hybrid vehicle is expected to combine the advantages of an automobile such as stability and weather protection, with the benefits of a Pedelec such as lightness, space utilization as well as energy consumption and which can be operated in the infrastructure that is currently available. A broad-based team has already evaluated different conditions, conducted a market analysis and set its own benchmarks. Schaeffler's innovation team also tested possible business models and fields of application.

One- or two-seater, three or four wheels, with roof or storage space for cargo – micromobility has many faces, as these models show

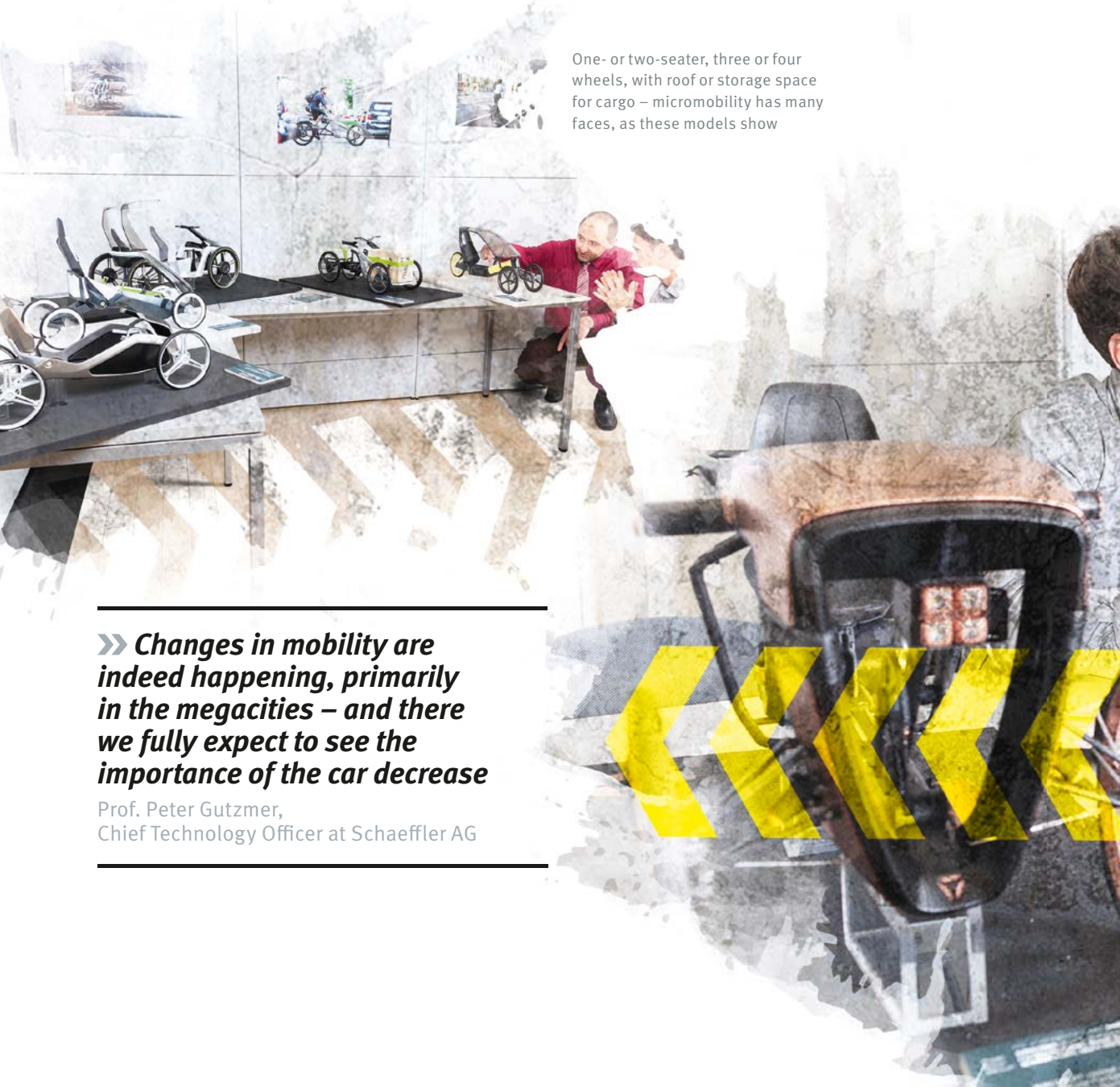

---

**» Changes in mobility are indeed happening, primarily in the megacities – and there we fully expect to see the importance of the car decrease**

Prof. Peter Gutzmer,  
Chief Technology Officer at Schaeffler AG

---

Thus, micromobility addresses several types of mobility and can be integrated in future-oriented means of transportation in the changing mobility patterns. After creating several design studies, the first solution concept is now ready to roll.

In the development, the company falls back on its long-standing expertise in engineering and manufacturing. Combining a holistic approach with systematic thinking and electromechanical know-how, the mobility supplier is in the position to develop cross-disciplinary concepts. By combining the knowledge from the industry and automotive field, the cross-functional development work and a broad network Schaeffler advances such projects with a 360-degree perspective.



## THE AUTHOR

*Jakub Fukacz is a member of the Schaeffler Automotive Communication team and is responsible for, amongst other things, the areas of technology and motorsport. As an avid communicator, the qualified sports scientist and communications manager has worked in the car business for more than six years. The native of Cologne is already trying to impart his passion for motor racing, skiing and basketball to his 18-month old daughter.*

Schaeffler's innovations team is convinced: micromobility addresses several types of mobility and, as a future-oriented means of transportation, can be integrated in the changing mobility patterns





# ELECTRIC LAZYLAND?

Mouse click instead of spanner: thanks to networked cars and progressive electromobility, defective vehicles will soon be repaired by the press of a button – even remotely from distance. However, the technology carries both opportunities and risks.

— by Tom Teßmer

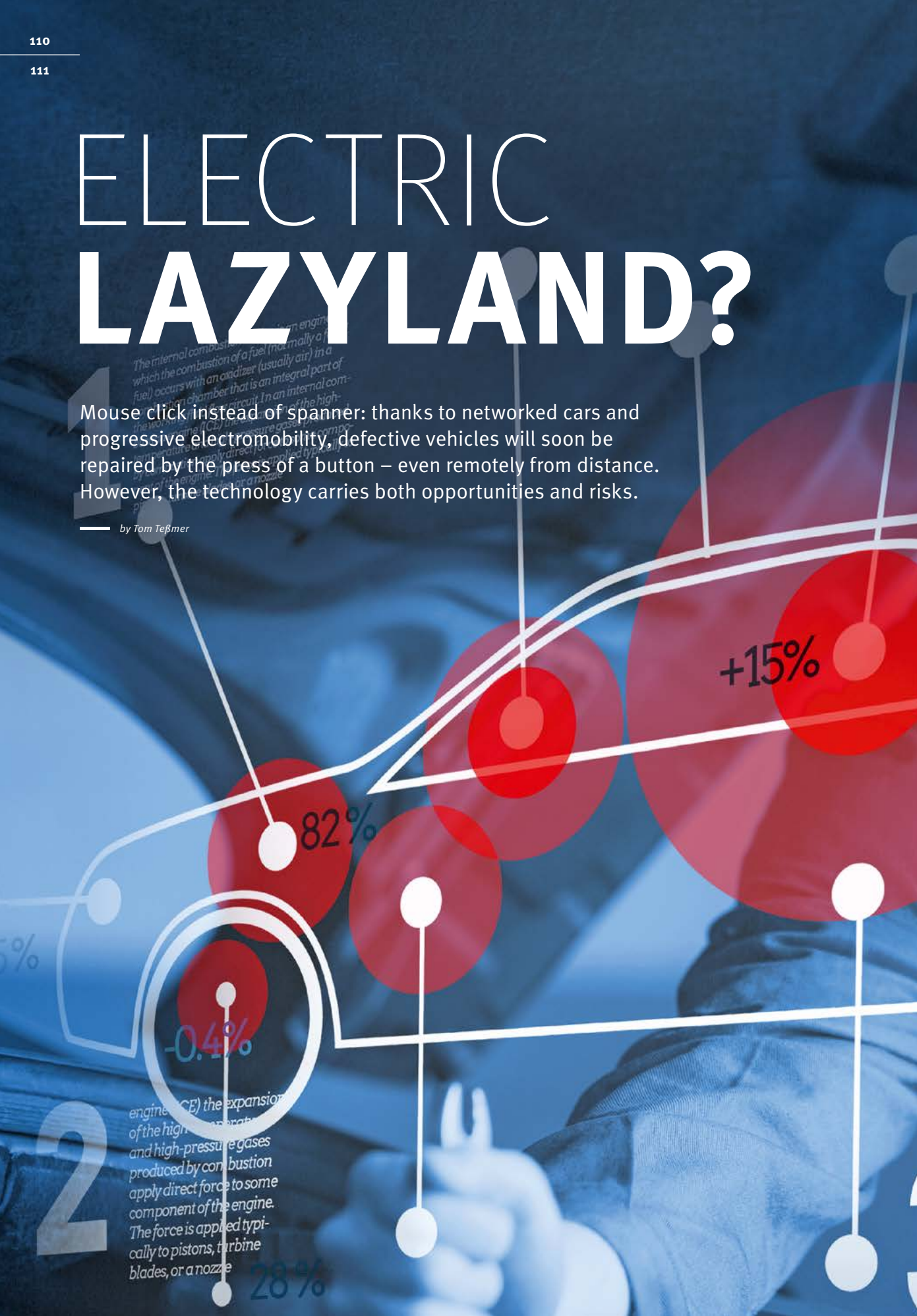

82%

+15%

-0.4%

28%

2

engine (ICE) the expansion of the high-temperature and high-pressure gases produced by combustion apply direct force to some component of the engine. The force is applied typically to pistons, turbine blades, or a nozzle

The internal combustion engine is an engine in which the combustion of a fuel (traditionally a fuel) occurs with an oxidizer (usually air) in a combustion chamber that is an integral part of the engine's structure. In an internal combustion engine, the combustion chamber is a cylinder. The high-temperature and high-pressure gases produced by combustion apply direct force to some component of the engine. The force is applied typically to pistons, turbine blades, or a nozzle

4  
 engine (ICE) the expansion of the high-temperature and high-pressure gases produced by combustion apply direct force to some component of the engine. The force is applied typically to pistons, turbine blades, or a nozzle

78%

35%

3  
 engine (ICE) the expansion of the high-temperature and high-pressure gases produced by combustion apply direct force to some component of the engine. The force is applied typically to pistons, turbine blades, or a nozzle

— The mechanic opens the car's hood. Looks around. Turns this screw, opens that lid. Knocks here, shakes there. In the old days, work in a car workshop was real manual labor. Carried out by guys wearing greasy overalls. Today in squeaky clean halls diagnostic computers are connected to the cars to identify minor problems. Mechanics have long since been mechatronic technicians, whereby the 'mecha' must rapidly make way for the 'tronic.'

No surprise: networked driving, infotainment and driver assistance systems have become indispensable in the 21<sup>st</sup> century automobile. Names from IT and internet companies like Apple, Google, IBM and Microsoft emerge ever more often in announcements from the automotive sector. In their advertisements, the car manufacturers now court the marketplace more with the latest multimedia features than with hp and numbers of cylinders. They surpass themselves with innovations, which in turn brings short innovation cycles to the electronic industry. The result: motoring is changing radically. Audi CEO Rupert Stadler hit the nail on the head: "Audi's goal is not only to improve the automobile, but to redefine mobility."

---

### ***Welding was yesterday, bonding and riveting is tomorrow***

---

A direction that not just Audi is pursuing. The march into the automobile future leads via intelligent and comprehensive networking. For workshops, though, this results in a two-front fight: In addition to networking the cars with their outside world, other automotive sectors like the increasingly varied and more complex drivetrain concepts make it indispensable for workshops to develop into high-tech businesses. "In connection with the growing electrification under the vehicle body as well as the networked computerization with the outside world, the workshop, a refuge for mechanics for over a hundred years, faces far-reaching change," predicts Prof. Dr. Norbert Schreier, expert for automobile and service technology as well as vehicle diagnostic for the Faculty of Automotive Engineering at Esslingen University. Even the good old sheet metal is on the retreat. Plastics are gaining ground (see page 90). Prof. Dr. Schreier tells his students: "Welding was yesterday, bonding and riveting is tomorrow."



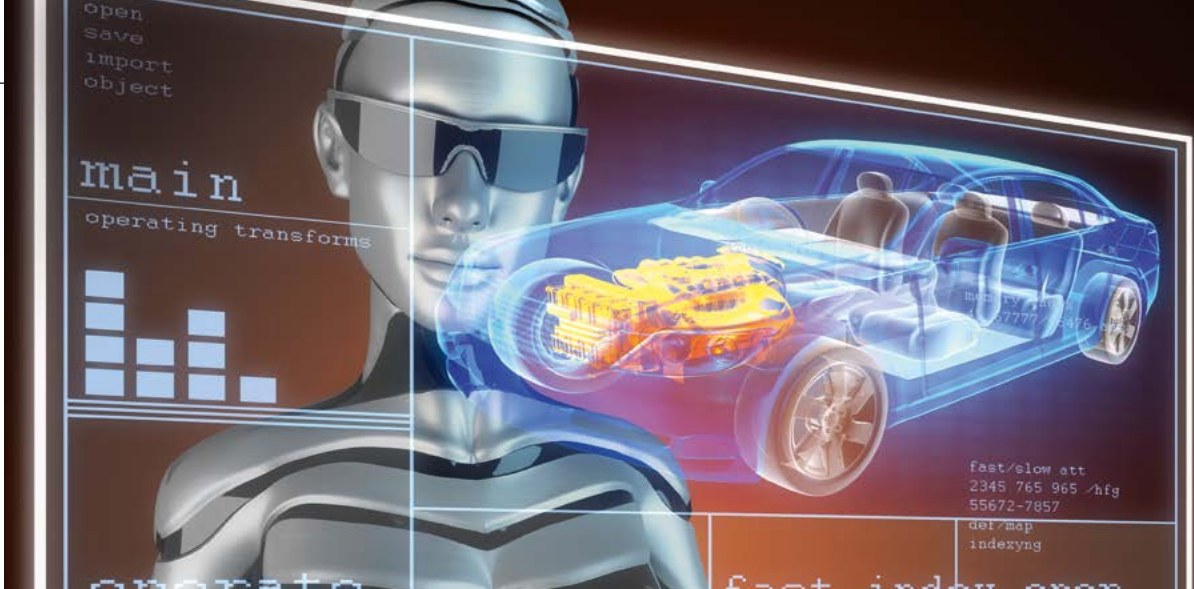

# 20

**DIN A4 files** are required to store the circuit diagrams of a current car. In the 1970s a single DIN A4 sheet was sufficient.

Source: Technisch-Literarische Gesellschaft e. V.

# 4,000

**wires** with a combined length of six kilometers are fitted to a current midsize car – in the Mercedes 170V built in the 1940s, it was 40 wires.

Source: elektroniknet.de

# 50%

of all **car related service procedures** are already completed with the help of computers.

Source: Fraunhofer Institute

As a bottom line, the role of the car workshop needs to be redefined. When the automobile pursues innovative paths, the workshop must follow suit at the same pace. The trend is towards larger workshops equipped with expensive diagnostic devices and special tools. Companies that do not keep pace have a bleak future. The Institute for the Automobile Industry (IFA) assumes that the number of car workshops will reduce by almost ten percent in the forthcoming years. According to the study, the average number of cars looked after per work will increase from 1,440 currently to 1,700 by 2025. “The workshop of the future will transform over time into an operating theatre,” says IFA Director Willi Diez.

### ***Workshop, Apple store and fashion boutique all in one***

However, what does the perfect workshop look like in the year 2020+x? The innovations agency Dominic Schindler Creations GmbH ventures a surprising prognosis. In the Austrians’ future vision not even the name ‘workshop’ has a place. If the car owner hands his sick car to helping hands then into a so-called repair center, a combination of workshop, Apple store and fashion boutique. Between the manufacturer’s accessories and fashion goods as well as image films and test drives on a simulator, the customers can submerge themselves in a world of mobility. The future motorist is also in safe hands when traveling in their networked

car. All the relevant information – from simple things like tire pressures to complex maintenance-relevant information like exhaust management, brake wear or pending service intervals – is compiled and can be read easily from the windshield. The dedicated on-board diagnostic system projects the necessary information onto the windshield. On the basis of which and within a few moments the driver can request binding offers from a suitable authorized workshop and coordinate a suitable time for the repair. The workshop is informed

### **SCHAEFFLER IN THE WORKSHOPS**

*Schaeffler Automotive Aftermarket represents the INA, FAG, LuK, and Ruville brands in the global spare parts business. More than 40,000 different products cover applications in the areas of the drive train, engine and suspension – in OE quality and for all vehicle categories up to trucks and agricultural machines. In addition, Schaeffler offers services for garages and retailers, including REPERT. With its online portal, Schaeffler assists garages around the globe in their daily operations by providing current vehicle data and detailed information. Local support and training programs complement Schaeffler’s offering.*

about every detail of the pending repair, spare parts are ordered and the availability of any necessary special tools is checked so that the workshop visit runs as efficiently as possible.

---

### ***Independent workshops face their greatest challenge***

---

So far, so good. However, what currently gives unaffiliated car workshops a headache is the question who determines where the car sends its data. As a result, the subject of data protection becomes a passenger in the car. Automobile clubs and numerous industry associations insist on legal regulations, which guarantee that the driver alone decides which information which third party can access. The unaffiliated companies strongly recommend that data-autonomy on the part of the vehicle owner is a prerequisite for fair competition in the car business. In the near future, do BMWs only communicate with BMW workshops, and is relevant repair data for a Renault only transmitted to the Renault garage foreman? Then adios you 'independents.'

The possibility for cars to transmit data to third parties will actually be mandatory in the EU for newly registered vehicles from 2018. However, the system named eCall is used solely for the automatic transmission of an emergency signal after a serious accident. However, you don't carry a mobile phone around just to call the police in an emergency. It goes without saying that the manufacturers will use the existing system for other purposes.

As much as the industry is in a state of upheaval as it moves towards virtuality, some things never change: in the coming decades there will still be real cars, which will be taken to independent workshops for standard repairs. However, the bottom line is that anyone wishing to survive in the cutthroat workshop business must invest: in appliances like a 3D printer, which produces spare parts 'just in time' on location, but also in the training and further education of personnel. Because in the future no workshop will get a car running like clockwork again with just an expert glance under the bonnet and a little listening, looking and twisting of spanners. 

---



#### **THE AUTHOR**

**Tom Teßmer** (born in 1979), passionate Volkswagen bus driver, went in search of his personal 'workshop of the future' after researching this story. His former trusty 'spanner' shut up shop and started an

open ended world tour.

## A WORKSHOP TREND: FAREWELL THROW-AWAY MENTALITY

**The workshop sector races at full speed towards a high-tech future.** In one area, however, it's called 'back to the roots.' When the carburettor used to play up it was often enough to change a spring, the throttle cable or a flap. All for just a few dollars. In the worst case, a refurbished exchange part or even something useable from the scrapyards was used. If an engine judders today, the ABS or air-conditioning grumbles then the complete control electronics are quickly exchanged. With older cars, such a failure amounts to a total financial loss. Annoying if the car is still mechanically healthy. The German research project 'Kfz Service Engineering 2020' implemented by the Fraunhofer Institute for Manufacturing Engineering and Automation in Stuttgart, University Bayreuth and the Upper Franconian Chamber of Craft Industries, addresses this issue.

For Prof. Rolf Steinhilper, the project initiator, the automobile trade faces the challenge of repairing electronic components instead of changing them. No easy task as the lover of vintage French cars is acutely aware: "Even today cars are four-wheel computer centers. Over 70 small computers, with more computing power than the Apollo 11 lunar rocket, control the on-board electronics in a large sedan." The fact that electronic components are becoming increasingly delicate doesn't make a repair any easier. Even today the complete computing power of an Audi A4 fits on a printed circuit board of DIN A5 format.

However, Steinhilper is optimistic that his mission will be successful. Ultimately there are many winners: the trade is delighted about increasing added value, because in the workshops more work and repairs will be billed as a result. For suppliers, additional sales opportunities arise with new profit margins – assuming of course that in the future the possibility of repairing the parts is already considered during its manufacture. In addition, repairing or fitting reprocessed parts conserves resources. Greater recycling and remanufacturing promote economic benefit. It goes without saying that the customer also benefits from the principle 'repair instead of new', as they can expect lower invoice costs and return to the roads satisfied with their vehicle. The project costs 3.5 million Euro. The cooperation partners and the Bavarian state bear the costs.



# MASTHEAD

## Published by

Schaeffler AG  
Industriestraße 1–3  
D-91074 Herzogenaurach  
www.schaeffler.com

## Communications, Marketing and Investor Relations

Christoph Beumelburg  
(Senior Vice President)  
Jörg Walz (Automotive)  
Martin Adelhardt (Industry)  
Jasmin Löffler (Corporate)

## Concept

Jörg Walz (Schaeffler)  
Thomas Voigt (Speedpool)

## Editor-in-Chief

Jörg Walz

## Executive Editor

Volker Paulun

## Coordination

Carina Chowanek, Julia Koop, Anke von Lübken

## Pre-press Stage

Julien Gradtke, Mathias Mayer

## Printing

Wünsch Druck GmbH

## Authors

Thomas Arndt, Dr. Joachim Becker, Wiebke Brauer, Jakub Fukasz, Claus Gorgs, Alexandra Grossmann, Jan Horst, Brigitte von Imhof, Martin Kaluza, Marco Kraft, Lars Krone, Christiane Kühl, Andrea Neumeyer, Carsten Paulun, Stefan Schlott, Christian Schmidt, Mark Schneider, Torben Schröder, Lukas Stelmaszyk, Tom Teßmer, Johannes Winterhagen, Roland Zumsande

## Editorial Team and Production

Speedpool GmbH  
www.speedpool.com

## Copy Editors

David Feist, Volker Hummel,  
Christoph Kirchner

## English Translation

Kaye Müller, Helga Oberländer

## Graphic Design

Manuela Mrohs (AD), Gökhan Agkurt,  
Oliver Breilmann, Jana Herbst,  
Mariessa Rose, Thomas Wildelau

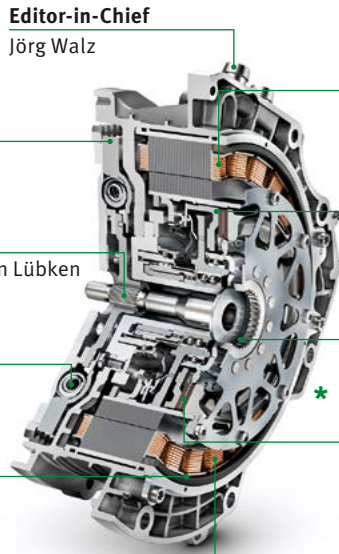

## Photo Credits

Front page: Colin Anderson/Getty; p. 3: Schaeffler; pp. 4/5: Susanne Eeg/Lödige, UniversalImagesGroup/Getty, Dennis Grombkowski/Getty, NASA; pp. 6/7: Susanne Eeg/Lödige; pp. 8–15: Johannes Eisele, Gerhard Joren, Daniel Berehulak, China Photos, Lost Horizon Images, Lonely Planet Images, ChinaFotoPress, Flickr RF, De Agostini/all Getty; pp. 16/17: Jörg Gläscher (2), Caterpillar; pp. 18/19: Allan Gichigi; pp. 20/21: Martin Kaluza (2), Fairfax Media/Getty; pp. 22/23: Mammoet, Scania CV AB; pp. 24/25: Colin Anderson/Getty, Daimler AG, Brigitte von Imhof; pp. 26–31: Hindustan Times, ChinaFotoPress, Frederic J. Brown/all Getty; pp. 32/33: CASE IH, Fendt, Williams Brothers; pp. 34/35: ROPA, Forstbetrieb Hipp, RAUCH; p. 36: Petra Stüning/ERO, Le Coiffeur Tractor Pulling Team Germany; pp. 38/39: UniversalImagesGroup/Getty; pp. 40–45: tai111/Fotolia (4); pp. 46–53: Getty (26), Wikipedia (6), Jastrow/Wikipedia, Carl von Canstein, Guy Immega/Wikipedia, Coolcaesar/Wikipedia; pp. 54–61: Max Etzold; pp. 62–65: Fotolia; pp. 66/67: Dennis Grombkowski/Getty; pp. 68–71: ShpilbergStudios/Fotolia, Schaeffler (5); pp. 72–77: Ken Hermann/Getty (3), Max Etzold (3); p. 78: Deutsches Patent- und Markenamt; p. 80: ullstein bild; pp. 82–85: Hoch Zwei; pp. 88/89: NASA; pp. 90/91: BMW; pp. 92/93: Audi, Colourbox (3), BMW; p. 94: Leif Piechowski; p. 95: Airbus (2); pp. 96/97: Ikon Images/Getty Images; p. 98: Bonnier Corporation/Getty; p. 99: Daewoo; p. 100: Honda, Schaeffler; p. 101: Ekso Bionics; pp. 102/103: Konstantin Sutyagin/Fotolia; pp. 104/105: Andy Ryan/Getty; pp. 106/107: on3studio; pp. 108/109: Max Etzold (2); pp. 110/111: Wavebreakmedia/Fotolia; p. 112: videodoctor/Fotolia

---

**DON'T MISS  
THE NEXT ISSUE OF  
tomorrow**

We'll be pleased to include  
you in our mailing list  
[tomorrow@schaeffler.com](mailto:tomorrow@schaeffler.com)

---



All issues are also available in  
digital form in our media library  
[www.schaeffler.de/en/tomorrow](http://www.schaeffler.de/en/tomorrow)

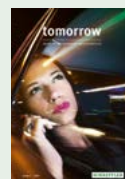

01/2015



02/2015



03/2015



01/2016

---







0 2884357 2



73



**WEB WORLDS**  
*Discover innovations  
for tomorrow on the  
internet*  
[schaeffler.com](http://schaeffler.com)